

Atman® 创星 NEW

PRODUCT | 新品手册



Atman® 创星

CCTV | 发现之旅
《工匠精神》入选企业

中山创星电器有限公司

地址: 广东省中山市小榄镇埗东村四十亩工业区(联丰路)
电话: 86-0760-23383398 传真: 86-0760-22121951

CHUANGXING ELECTRIC APPLIANCES CO.,LTD

Address: Lianfeng Road, Liedong Village, Xiaolan Town,
Zhongshan, Guangdong, P.R.C.
Tel: 86-0760-23383398 Fax: 86-0760-22121951

香港创星制品有限公司

地址: 香港新界荃湾沙咀道26-38号汇力工业中心3楼31室
电话: 852-24131336 传真: 852-24131116

CHUANGXING MANUFACTURING CO.,LTD

Address: No.31, 3/F, Thriving Industrial Ctr., 26-38 Sha Tsui
Road, Tsuen Wan, N.T., Hong Kong
Tel: 852-24131336 FAX: 852-24131116



品质铸就放心水族



ABOUT US

关于 我们

中山市创星电器有限公司 (ATMAN) 始建于1991年, 位于广东省中山市, 是一家接外加工 (OEM&ODM) 和集自主研发、生产、销售于一体的大型自动化水族制造企业。凭借30多年水族领域的经验, 成为中国高端水族产品制造商, 并与多个国际大品牌合作。

我们的产品涵盖淡水类及海水类产品, 其中包括鱼缸、过滤器、气泵、水泵、水族照明、加热棒等, 共计200多个品种。款式多样, 规格齐全, 通过多类认证, 能符合各类市场需求。

过去, 创星以品质走出了自己的品牌之路, 赢得了极佳市场口碑。未来, 我们将坚定“质量是企业的生命”的信念, 把创星打造“合作放心, 品质放心, 选配放心, 售后放心”的首家放心水族。

Zhongshan Chuangxing Electrical Appliance Co.,Ltd (ATMAN) was founded in 1991 and is located in Zhongshan city, Guangdong Province. Chuangxing is one of the largest aquarium manufacturer with research and development, production and sale, and we provide OEM and ODM service. With over 30 years experience in aquarium field, we has grown to become the top 10 aquarium products manufacturer in China and has been cooperated with many international brands. We are able to understand the specific demands of the hobbyist and develop the professional product to fit into the market trend.

We offer more than 200 varieties of fresh water and marine products with various certifications, which cover wide range of aquarium tank, filter, air pump, water pump, aquarium lighting and heater etc. It can accord with the demands of the market.

We truly believe that 'Quality is the heart of company's success'. We are always dedicated to be the best cooperative partner and creating practical and trusted products.

CONTENTS 目录

鱼缸

- NEW** 01 XR三合一鱼缸
XR 3 in 1 fish tank
- NEW** 03 MINI种植鱼缸
MINI planting fish tank
- 05 小型玻璃鱼缸
Small glass tank
- NEW** 01 ZGT直角套缸
ZGT right angle set tank
ZGT直角单缸
ZGT right angle tank
- 03 HA半圆鱼缸
HA semi-circle tank
- NEW** 05 直角套缸
Right angle set tank
- NEW** 02 RGT圆角套缸
RGT round angle set tank
RGT圆角单缸
RGT round angle tank
- 04 CR前弧鱼缸
CR front arc tank
- NEW** 05 乌龟缸
Tortoise tank
- NEW** 02 BGT半圆套缸
BGT semicircle set tank
BGT半圆单缸
BGT semicircle tank
- 04 AR前弧鱼缸
AR front arc tank

过滤器

- NEW** 06 AT缸外过滤桶
AT canister filter
- 08 EF池/缸过滤桶
EF pond/tank canister filter
- NEW** 10 SP缸内背挂过滤器
SP back hanging filter
- NEW** 12 NZ内置过滤器
NZ internal filter
- 14 AT-F300内置过滤器
AT-F300 internal filter
- 16 SIF内置过滤器
SIF internal filter
- NEW** 06 RF缸外过滤桶
RF canister filter
- NEW** 08 QZ前置过滤器
QZ prefilter
- 10 HF-B背挂过滤器
HF-B back hanging filter
- NEW** 12 SKF三角过滤器
SKF corner filter
- 14 PF内置过滤器
PF internal filter
- 16 AT内置过滤器
AT internal filter
- 07 CF缸外过滤桶
CF canister filter
- NEW** 09 Q7外挂过滤桶
Q7 back hang canister filter
- 11 HF背挂过滤器
HF back hanging filter
- 13 AT-F100内置过滤器
AT-F100 internal filter
- 15 AT-1000/1500/2500内置过滤器
AT-1000/1500/2500 internal filter
- 07 CF/UF缸外过滤桶
CF/UF canister filter
- NEW** 09 HK外挂过滤盒
HK back hanging filter
- 11 AT内置过滤器
AT internal filter
- 13 AT-F200内置过滤器
AT-F200 internal filter
- 15 TSF三角过滤器
TSF corner filter

水泵

- NEW** 17 RX可控变频造浪泵
RX frequency conversion wave maker pump
- NEW** 19 AX可控变频水泵
AX frequency conversion water pump
- 21 DP池塘泵
DP pond pump
- 23 PH潜水泵
PH water pump
- 25 AT-400潜水泵
AT-400 water pump
- NEW** 17 PX可控变频横流泵
PX frequency conversion wave maker pump
- NEW** 20 DX变频水泵
DX variable frequency water pump
- NEW** 22 HAX变频锦鲤池泵
HAX kam carp pond frequency conversion pump
- 24 AT-101s潜水泵
AT-101s water pump
- 26 AT-600节能水泵
AT-600 water pump
- NEW** 18 BX造浪泵
BX wave maker pump
- NEW** 20 AT变频水泵
AT variable frequency water pump
- 22 HA锦鲤池泵
HA kam carp pond pump
- 24 AT-200潜水泵
AT-200 water pump
- NEW** 26 USB水泵
USB water pump
- NEW** 18 MX可控变频水泵
MX frequency conversion water pump
- 21 MP水泵
MP water pump
- NEW** 23 TF3合1潜水泵
TF 3 in 1 water pump
- 25 AT-300s潜水泵
AT-300s water pump
- 26 AT盘景水泵
AT miniscape pump

气泵

- NEW** 27 BP双倍静气泵
BP Silent air pump
- NEW** 29 DP气泵
DP air pump
- 31 AP气泵
AP air pump
- 33 HP气泵
HP air pump
- 34 干电池气泵
Battery air pump
- NEW** 27 AD交/直流充电气泵
AD AC / DC charging air pump
- 29 HP气泵
HP air pump
- 31 AT-A气泵
AT-A air pump
- 33 AT&EP气泵
AT&EP air pump
- 28 XP气泵
XP air pump
- 30 CR气泵
CR air pump
- 32 AR气泵
AR air pump
- 34 山本气泵
Shanben air pump
- NEW** 28 KP水族气泵
KP air pump
- 30 PP气泵
PP air pump
- 32 CX气泵
CX air pump
- 34 B-1500气泵
B-1500 air pump

加热棒

- NEW** 35 MJ数控电热膜加热棒
MJ numerical control heater
- 37 BH石英加热棒
BH quartz heater
- NEW** 39 FH玻璃加热棒
FH glass heater
- 36 GH石英加热棒
GH quartz heater
- 38 CH玻璃加热棒
CH glass heater
- 40 J25玻璃加热棒
J25 glass heater
- NEW** 36 JG玻璃加热棒
JG glass heater
- 38 DH玻璃加热棒
DH glass heater
- 40 J16恒温加热棒
J16 fixed temperature heater
- 37 AH石英加热棒
AH quartz heater
- 39 EH玻璃加热棒
EH glass heater

水族灯

- NEW** 41 LG/LGM LED超薄水族灯
LG/LGM LED ultra-thin aquarium lamp
- 43 LA LED水族灯
LA LED aquarium lamp
- NEW** 42 CX LED智能水族灯
CX LED smart aquarium lamp
- 43 LP 椭圆水族灯
LP aquarium lamp
- NEW** 42 QL-60 LED智能水族灯
QL-60 LED smart aquarium lamp
- 44 UV杀菌灯
UV lamp
CASE UV杀菌灯
CASE UV lamp
- 43 LA LED超薄水族灯
LA LED ultra-thin aquarium lamp
- 44 UV杀菌灯
UV lamp

水草用具

- NEW** 45 自吸式除油膜器
Self suction surface skimmer
- 46 二氧化碳扩散器
CO2 diffuser
- 46 鱼缸刮铲
Fish tank brush

其他产品

- NEW** 47 AF-02/03自动喂食器
AF-02/03 automatic feeder
- 48 工艺喷泉头
Fountain head
- NEW** 47 AF-04自动喂食器
AF-04 automatic feeder
- 49 磁力双头鱼缸刮刷
Magnetic double scraper brush
- 48 AFT自动喂食器
AFT automatic feeder
- 48 水妖精
Sponge filter
- 49 磁力鱼缸刷
Magnetic brush

XR三合一鱼缸 XR 3 IN 1 FISH TANK NEW



触摸式LED灯(Touch LED lamp)

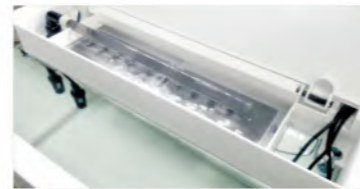

顶部过滤(Top filter)

- 外形采用环保ABS材质，缸体圆角造型。
- 采用台湾汽车玻璃运用热弯技术一体成型。
- 集顶部过滤与触摸式LED灯于一体。

- The shape of the use of environmentally-friendly ABS material, cylinder rounded shape.
- Taiwan automotive glass using hot bending technology integrated molding.
- Set top filter and touch type LED lamp in one.

110~120V 60Hz / 220~240V 50Hz

| 型号 Model | 产品尺寸 Product size | 容量 Capacity | LED灯功率 LED lamp power | 纸箱尺寸 Carton size | 件/箱 pcs/ctn | 重量 Weight |
|-------------|----------------------|----------------|--------------------------|---------------------|----------------|--------------|
| XR-320 | 32.6x24x31.8cm | 24.8L/6.5gal | 6w | 37x28x38.5cm | 1/1 | 4.9kg |
| XR-380 | 38x25x37cm | 35.1L/9.3gal | 8.6w | 43x29.5x43cm | 1/1 | 7.5kg |
| XR-510 | 50.8x30x42.8cm | 65.2L/17.2gal | 12.5w | 57.5x37.5x51cm | 1/1 | 11.3kg |
| XR-600 | 60x33x45cm | 89.1L/23.5gal | 15w | 67x40.2x53cm | 1/1 | 14.4kg |
| XR-800 | 80x38x50cm | 152L/40.1gal | 17w | 87.5x46x60cm | 1/1 | 24.4kg |
| XR-1000 | 100x43x55cm | 236L/62.3gal | 24w | 107x42.5x57cm | 1/1 | 39.0kg |



RGT圆角套缸 RGT RIGHT ANGLE SET TANK NEW



- 圆角高清玻璃鱼缸。
- 轻触LED灯，节能高亮，蓝白两种灯效。
- 缸内背挂过滤，滤材更换方便。

- Round angle HD glass fish tank.
- Touch LED light, energy saving and bright, blue and white lights.
- Built in back hung filter, easy to change filter materials.



110~120V 60Hz / 220~240V 50Hz

颜色 colour

| 型号 Model | 鱼缸 Fish tank | 过滤 Filter | 水族灯 Aquarium lamp | 玻璃上盖 Glass cover | 纸箱尺寸 Carton size | 件/箱 pcs/ctn | 重量 Weight |
|-------------|-----------------|--------------|----------------------|---------------------|---------------------|----------------|--------------|
| RGT-35 | RG-35 | SP-200 | CX-MP | ✓ | 36x19x26.4cm | 1/1 | 4.3kg |
| RGT-40 | RG-40 | SP-200 | CX-MP | ✓ | 41x19x26.4cm | 1/1 | 4.5kg |



| 型号 Model | 产品尺寸 Product size | 容量 Capacity | 玻璃上盖 Glass cover |
|-------------|----------------------|----------------|---------------------|
| RG-35 | 35.4x18.4x26cm | 13L/3.43gal | ✓ |
| RG-40 | 40.4x18.4x26cm | 18L/4.75gal | ✓ |

ZGT直角套缸 ZGT RIGHT ANGLE SET TANK NEW



- 直角高清玻璃鱼缸。
- 轻触LED灯，节能高亮，蓝白两种灯效。
- 缸内背挂过滤，滤材更换方便。

- Right angle HD glass fish tank.
- Touch LED light, energy saving and bright, blue and white lights.
- Built in back hung filter, easy to change filter materials.



110~120V 60Hz / 220~240V 50Hz

颜色 colour

| 型号 Model | 鱼缸 Fish tank | 过滤 Filter | 水族灯 Aquarium lamp | 玻璃上盖 Glass cover | 纸箱尺寸 Carton size | 件/箱 pcs/ctn | 重量 Weight |
|-------------|-----------------|--------------|----------------------|---------------------|---------------------|----------------|--------------|
| ZGT-20 | ZG-20 | SP-200 | CX-SP | ✓ | 23x23x26.3cm | 1/1 | 3.6kg |
| ZGT-30 | ZG-30 | SP-200 | CX-SP | ✓ | 31x23x27.2cm | 1/1 | 4.4kg |
| ZGT-40 | ZG-40 | SP-500 | CX-LP | ✓ | 41x26x31cm | 1/1 | 7.2kg |
| ZGT-50 | ZG-50 | SP-500 | CX-LP | ✓ | 51x26x34cm | 1/1 | 8.8kg |
| ZGT-60 | ZG-60 | SP-800/Q7-M | QL-60 | ✓ | 60.6x33.6x39cm | 1/1 | 10.5kg |



| 型号 Model | 产品尺寸 Product size | 容量 Capacity | 玻璃上盖 Glass cover |
|-------------|----------------------|----------------|---------------------|
| ZG-20 | 22.4x22.4x26cm | 12L/3.17gal | ✓ |
| ZG-30 | 30.4x22.4x27cm | 17L/4.49gal | ✓ |
| ZG-40 | 40.4x25.4x31cm | 30L/7.92gal | ✓ |
| ZG-50 | 50.4x25.4x34cm | 41L/10.8gal | ✓ |
| ZG-60 | 60x33x39cm | 75L/16gal | × |
| ZG-80 | 80x39x46cm | 140L/30gal | × |

BGT半圆套缸 BGT SEMICIRCLE SET TANK NEW



- 半圆高清玻璃鱼缸。
- 轻触LED灯，节能高亮，蓝白两种灯效。
- 缸内背挂过滤，滤材更换方便。

- Semicircle HD glass fish tank.
- Touch LED light, energy saving and bright, blue and white lights.
- Built in back hung filter, easy to change filter materials.



110~120V 60Hz / 220~240V 50Hz

颜色 colour

| 型号 Model | 鱼缸 Fish tank | 过滤 Filter | 水族灯 Aquarium lamp | 玻璃上盖 Glass cover | 纸箱尺寸 Carton size | 件/箱 pcs/ctn | 重量 Weight |
|-------------|-----------------|--------------|----------------------|---------------------|---------------------|----------------|--------------|
| BGT-25 | BG-25 | SP-200 | CX-SP | ✓ | 26.5x22.5x27.5cm | 1/1 | 3.7kg |
| BGT-30 | BG-30 | SP-200 | CX-SP | ✓ | 31.5x24.5x32.5cm | 1/1 | 4.5kg |



| 型号 Model | 产品尺寸 Product size | 容量 Capacity | 玻璃上盖 Glass cover |
|-------------|----------------------|----------------|---------------------|
| BG-25 | 25.4x21x26cm | 10L/2.62gal | ✓ |
| BG-30 | 30.4x23x29cm | 16L/4.22gal | ✓ |

MINI种植鱼缸 NEW

MINI PLANTING FISH TANK



- 高清亚克力鱼缸，顶部植物槽可种植。
- LED灯，节能高亮，白色灯效。
- 内置背挂过滤，滤材清洗，更换方便。
- 低压输出防触电。

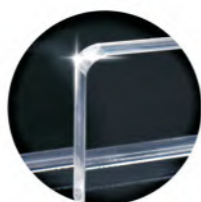

高清亚克力缸
HD acrylic tank



内置背挂过滤
Internal filter



LED水族灯(蓝白)
LED lamp(Blue and white)



低压输出防触电
Low voltage safety



Input:100-240V Output:DC 12V

| 型号 Model | 功率 Power | 流量 Q _{max} | 鱼缸尺寸 Tank size | 纸箱尺寸 Carton size | 件/箱 pcs/ctn | 重量 Weight |
|-------------|-------------|------------------------|-------------------|---------------------|----------------|--------------|
| MN-200 | 3.7W | 220L/H | 20×20×23.5cm | 43×43×28cm | 4/1 | 5kg |
| MN-280 | 3.7W | 220L/H | 20×28×23.5cm | 59×44×28cm | 4/1 | 5.4kg |

HA半圆鱼缸

HA SEMI-CIRCLE TANK



- 半圆高清玻璃鱼缸。
- LED水族灯。
- 顶部过滤。
- HD glass semi-circle tank.
- LED aquarium lamp.
- Upper filtration.

俯视图 Top view



110~120V 60Hz / 220~240V 50Hz

| 型号 Model | 鱼缸尺寸 Tank Size | 灯功率 Lamp power | 容积 Capacity | 纸箱尺寸 Carton size | 件/箱 pcs/ctn | 重量 Weight |
|-------------|-------------------|-------------------|----------------|---------------------|----------------|--------------|
| HA-380 | 38×24×39cm | 6.4w | 35L/9.3gal | 42×28×49.5cm | 1/1 | 6.8kg |
| HA-600 | 60×32×50cm | 8.8w | 96L/25.4gal | 62×37×61.5cm | 1/1 | 17.5kg |
| HA-690 | 90×50×56cm | 15.6w | 252L/66.6gal | 95.5×55.5×72.5cm | 1/1 | 36.0kg |

颜色
colour 银 silver 黑 black

CR前弧鱼缸

CR FRONT ARC TANK



- 前弧形高清玻璃鱼缸。
- 高亮LED水族灯。
- HD front ARC glass tank.
- LED aquarium lamp.

俯视图 Top view



110~120V 60Hz / 220~240V 50Hz

| 型号 Model | 鱼缸尺寸 Tank Size | 灯功率 Lamp power | 容积 Capacity | 纸箱尺寸 Carton size | 件/箱 pcs/ctn | 重量 Weight |
|-------------|-------------------|-------------------|----------------|---------------------|----------------|--------------|
| CR-320 | 31×32×33cm | 6.4w | 32L/8.5gal | 33.5×32.5×39.7cm | 1/1 | 7.6kg |
| CR-500 | 50×34×44cm | 8.8w | 74.8L/20.7gal | 54×37.5×54cm | 1/1 | 16.0kg |
| CR-600 | 60×36×48cm | 15.6w | 103L/27.2gal | 65×39×59.5cm | 1/1 | 19.4kg |
| CR-900 | 90×43×52cm | 19.8w | 201L/53.1gal | 97×46×65cm | 1/1 | 35.2kg |

颜色
colour 白 white 银 silver 黑 black 灰 gray

AR前弧鱼缸

AR FRONT ARC TANK

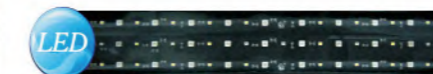

- 前弧形高清玻璃鱼缸。
- LED水族灯。
- 顶部过滤。
- HD front ARC glass tank.
- LED aquarium lamp.
- Upper filtration.

俯视图 Top view

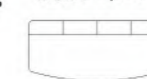

110~120V 60Hz / 220~240V 50Hz

| 型号 Model | 鱼缸尺寸 Tank Size | 灯功率 Lamp power | 容积 Capacity | 纸箱尺寸 Carton size | 件/箱 pcs/ctn | 重量 Weight |
|-------------|-------------------|-------------------|----------------|---------------------|----------------|--------------|
| AR-F380 | 38×25×39cm | 8.8w | 37L/9.8gal | 43×30×50.5cm | 1/1 | 8.8kg |
| AR-F510 | 51×34×46.5cm | 8.8w | 80L/21.1gal | 55.5×39.2×53.5cm | 1/1 | 16.3kg |
| AR-F620 | 62×39×43.5cm | 15.6w | 105L/27.7gal | 67.8×44.8×57.9cm | 1/1 | 20.4kg |
| AR-F830 | 83×43.5×48cm | 19.8w | 173L/45.7gal | 88.4×49×65cm | 1/1 | 35.5kg |
| AR-F980 | 100×46×50cm | 27w | 230L/60.8gal | 106×52×67.3cm | 1/1 | 53.5kg |

颜色
colour 白 white 银 silver 黑 black 灰 gray



小型玻璃鱼缸 SMALL GLASS TANK

- 高清玻璃鱼缸。
- 透明支架，环保ABS底框。
- HD glass tank.
- Transparent bracket, ABS bottom frame.

| 型号 Model | 鱼缸尺寸 Tank Size | 容积 Capacity | 重量 Weight |
|-------------|-------------------|----------------|--------------|
| S | 31.5×18.5×24.5cm | 14.2L/3.8gal | 2.0kg |
| M | 36×22×26.5cm | 20.9L/5.5gal | 2.6kg |
| L | 40×25.5×28cm | 28.5L/7.5gal | 3.1kg |

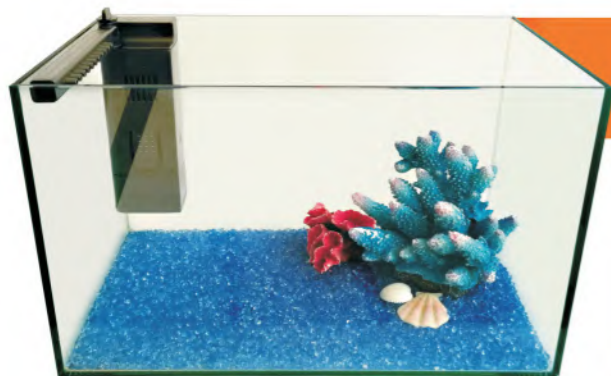

直角套缸 RIGHT ANGLE SET TANK

110~120V 60Hz / 220~240V 50Hz

| 型号 Model | 缸尺寸 Tank size | 选配过滤器 Optional filter | | | |
|-------------|------------------|--------------------------|------|--------|---------|
| 22 | 22×15×17cm | | | | |
| 30 | 30×18×20cm | HK-0300 | NZ-1 | MN-200 | SKF-200 |
| 35 | 35×20×22cm | HK-0400 | NZ-2 | | SKF-300 |
| 40 | 40×22×25cm | HK-0400 | NZ-3 | | |
| 45 | 45×25×28cm | HK-0600 | NZ-4 | | |
| 50 | 50×28×30cm | HK-0600 | NZ-5 | | |

- 直角高清玻璃鱼缸。
- 可配不同过滤器，组成不同的套缸。
- Right angle HD glass fish tank.
- It can be equipped with different filters to form different set tank.

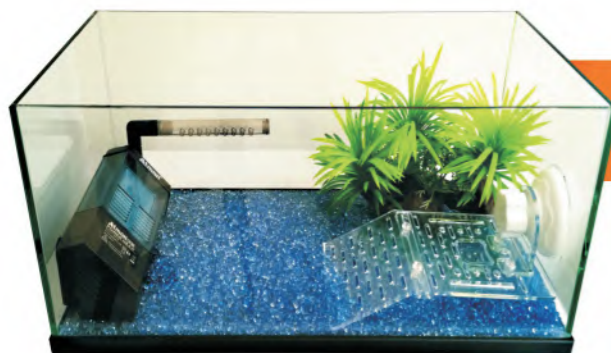

乌龟缸 TORTOISE TANK

110~120V 60Hz / 220~240V 50Hz

| 型号 Model | 缸尺寸 Tank size | 选配过滤器 Optional filter | |
|-------------|------------------|--------------------------|---------|
| 340 | 31.5×18.5×15.5cm | NZ-1 | |
| 390 | 40×25.6×16.5cm | NZ-1 | SKF-200 |
| 450 | 45×29.5×22.6cm | NZ-2 | SKF-300 |
| 600 | 60×29.5×27.5cm | NZ-3 | SKF-300 |

- 直角高清玻璃龟缸，ABS底框。
- 可配不同过滤器，组成不同的乌龟套缸。
- Right angle HD glass tortoise tank, ABS bottom frame.
- It can be equipped with different filters to form different tortoise set tank.

AT缸外过滤桶 AT CANISTER FILTER

- 高效滤水，流量可调。
- 按压排气，自动吸水。
- 多层滤篮，滤材自由配。
- 咸/淡水适用。
- Efficient filtration, adjustable flow.
- Water will be absorbed when push the exhaust button.
- Multi layer filter baskets, random matching of filter materials.
- Suitable for freshwater and marine water.



AT-3335S AT-3336S AT-3337S AT-3338S AT-3339S



| 编码 Code | 水阻 Water Flow | 电机座 Pumphead | 转子 Impeller | 机头胶圈 O-ring | 滤水桶 Filter Bucket | 配件包 Parts Package |
|------------|------------------|-----------------|----------------|----------------|----------------------|----------------------|
| AT-3335S | GY20140 | GY20149 | GY20139 | GY20138 | GY20146 | GY20142 |
| AT-3336S | | GY20148 | | | GY20147 | |
| AT-3337S | GY20115 | GY20130 | GY20119 | GY20118 | GY20112 | GY20124 |
| AT-3338S | | GY20129 | | | GY20110 | |
| AT-3339S | GY20106 | GY20107 | GY20174 | | GY20175 | GY20108 |

| 白棉 White Sponge | 黑棉 Black Sponge |
|--------------------|--------------------|
| GY20144 | GY20145 |
| GY20128 | GY20127 |

3个月更换 3 months replacement

110~120V 60Hz / 220~240V 50Hz

| 型号 Model | 功率 Power | 流量 Q.max | 过滤篮 Filter basket | 适用鱼缸 Suit For Aquarium | 出水口 Outlet | 产品尺寸 Product size | 纸箱尺寸 Carton size | 件/箱 pcs/ctn | 重量 Weight |
|-------------|-------------|-------------|----------------------|---------------------------|---------------|----------------------|---------------------|----------------|--------------|
| AT-3335S | 10w | 660L/H | 2 | 40-80cm | Ø12 | 19x19x31cm | 42x29.5x35.7cm | 2/1 | 8.4kg |
| AT-3336S | 10w | 660L/H | 3 | 60-90cm | Ø12 | 19x19x38cm | 42x29.5x41.5cm | 2/1 | 9.1kg |
| AT-3337S | 18w | 1400L/H | 2 | 80-120cm | Ø17 | 23x23x38cm | 49.6x33.5x41.5cm | 2/1 | 12.2kg |
| AT-3338S | 18w | 1400L/H | 3 | 90-150cm | Ø17 | 23x23x44cm | 49.6x33.5x48.5cm | 2/1 | 13.6kg |
| AT-3339S | 27w | 1800L/H | 4 | 100-180cm | Ø19 | 23x23x53cm | 51x37x55cm | 2/1 | 15.6kg |

RF缸外过滤桶 RF CANISTER FILTER

- 高效滤水，流量可调。
- 按压排气，自动吸水。
- 多层滤篮，滤材自由配。
- 咸/淡水适用。
- Efficient filtration, adjustable flow.
- Water will be absorbed when push the exhaust button.
- Multi layer filter baskets, random matching of filter materials.
- Suitable for freshwater and marine water.



RF-501 RF-701 RF-1001 RF-1301



| 编码 Code | 水阻 Water Flow | 电机座 Pumphead | 转子 Impeller | 机头胶圈 O-ring | 滤水桶 Filter Bucket | 配件包 Parts Package |
|------------|------------------|-----------------|----------------|----------------|----------------------|----------------------|
| RF-501 | | GY20178 | | | GY20184 | |
| RF-701 | GY20176 | GY20179 | GY20139 | GY20138 | GY20185 | GY20053 |
| RF-1001 | | GY20180 | | | GY20186 | |
| RF-1301 | GY20177 | GY20181 | GY20119 | GY20118 | GY20187 | GY20061 |

| 白棉 White Sponge | 黑棉 Black Sponge |
|--------------------|--------------------|
| GY20144 | GY20145 |
| GY20128 | GY20127 |

3个月更换 3 months replacement

110~120V 60Hz / 220~240V 50Hz

| 型号 Model | 功率 Power | 流量 Q.max | 过滤篮 Filter basket | 适用鱼缸 Suit For Aquarium | 出水口 Outlet | 产品尺寸 Product size | 纸箱尺寸 Carton size | 件/箱 pcs/ctn | 重量 Weight |
|-------------|-------------|-------------|----------------------|---------------------------|---------------|----------------------|---------------------|----------------|--------------|
| RF-501 | 12w | 820L/H | 2 | 40-80cm/40-150L | Ø12 | 22x22x34cm | 42x30x36cm | 2/1 | 10.0kg |
| RF-701 | 12w | 820L/H | 3 | 60-90cm/60-200L | Ø12 | 22x22x39cm | 42x30x41cm | 2/1 | 10.9kg |
| RF-1001 | 19w | 1250L/H | 2 | 80-120cm/150-250L | Ø17 | 26x26x40cm | 49x34x41cm | 2/1 | 14.5kg |
| RF-1301 | 19w | 1250L/H | 3 | 90-150cm/200-400L | Ø17 | 26x26x47cm | 49x34x48cm | 2/1 | 15.6kg |

CF缸外过滤桶 CF CANISTER FILTER

- 高效滤水，流量可调。
- 按压排气，自动吸水。
- 多层滤篮，滤材自由配。
- 咸/淡水适用。

- Efficient filtration, adjustable flow.
- Water will be absorbed when push the exhaust button.
- Multi layer filter baskets, random matching of filter materials.
- Suitable for freshwater and marine water.



| 消耗类配件 Consumption parts | | | | | | |
|-------------------------|---------------|--------------|-------------|-------------|-------------------|-------------------|
| 编码 Code | 水咀 Water Flow | 电机座 Pumphead | 转子 Impeller | 机头胶圈 O-ring | 滤水桶 Filter Bucket | 配件包 Parts Package |
| 型号 Model | | | | | | |
| CF-600 | | GY20084 | GY20088 | GY20077 | GY20085 | GY20081 |
| CF-800 | | GY20084 | GY20087 | GY20077 | GY20086 | GY20081 |
| CF-1000 | | GY20100 | GY20104 | GY20070 | GY20182 | GY20097 |
| CF-1200 | | | GY20105 | GY20094 | GY20183 | |

| 轮换类配件 Rotation parts | |
|----------------------|-----------------|
| 白棉 White Sponge | 黑棉 Black Sponge |
| GY20079 | GY20078 |
| GY20102 | GY20103 |

3个月更换 3 months replacement

110~120V 60Hz / 220~240V 50Hz

| 型号 Model | 功率 Power | 流量 Q.max | 过滤篮 Filter basket | 适用鱼缸 Suit For Aquarium | 出水口 Outlet | 产品尺寸 Product size | 纸箱尺寸 Carton size | 件/箱 pcs/ctn | 重量 Weight |
|----------|----------|----------|-------------------|------------------------|------------|-------------------|------------------|-------------|-----------|
| CF-600 | 12W | 720L/H | 2 | 40-70cm/40-160L | Ø12 | 22×22×34cm | 43.5×33.5×34cm | 2/1 | 10.0kg |
| CF-800 | 12W | 720L/H | 3 | 40-100cm/60-230L | Ø12 | 22×22×39cm | 43.5×33.5×40cm | 2/1 | 10.9kg |
| CF-1000 | 19W | 1300L/H | 2 | 70-120cm/150-450L | Ø17 | 26×26×40cm | 50×38×40.5cm | 2/1 | 14.5kg |
| CF-1200 | 19W | 1300L/H | 3 | 70-140cm/200-600L | Ø17 | 26×26×47cm | 50×38×47.8cm | 2/1 | 15.6kg |

CF/UF缸外过滤桶 CF/UF CANISTER FILTER

- 高效滤水，咸/淡水适用。
- 多层滤篮，超大容量，滤材自由配。
- CF能按压上水，UF带UV杀菌灯。

- Efficient filtration, suitable for freshwater and marine water.
- Multi layer filter baskets, super capacity, free matching of filter material.
- Water will be absorbed when push the CF exhaust button, UF with UV lamp.



| 消耗类配件 Consumption parts | | | | | | |
|-------------------------|---------------|--------------|-------------|-------------|-------------------|-------------------|
| 编码 Code | 水咀 Water Flow | 电机座 Pumphead | 转子 Impeller | 机头胶圈 O-ring | 滤水桶 Filter Bucket | 配件包 Parts Package |
| 型号 Model | | | | | | |
| CF-3200 | | GY20188 | | | | |
| CF-3400 | | GY20015 | | | | |
| UF-3200 | | GY20018 | GY20069 | GY20017 | GY20191 | GY20193 |
| UF-3400 | | GY20189 | | | GY20192 | GY20009 |

| 轮换类配件 Rotation parts | |
|----------------------|-----------------|
| 白棉 White Sponge | 黑棉 Black Sponge |
| GY20013 | GY20012 |
| GY20194 | GY20010 |

3个月更换 3 months replacement

110~120V 60Hz / 220~240V 50Hz

| 型号 Model | 功率 Power | 流量 Q.max | 过滤篮 Filter basket | UV UV | 排气按钮 Exhaust button | 适用鱼缸 Suit For Aquarium | 出水口 Outlet | 产品尺寸 Product size | 纸箱尺寸 Carton size | 件/箱 pcs/ctn | 重量 Weight |
|----------|----------|----------|-------------------|-------|---------------------|------------------------|------------|-------------------|------------------|-------------|-----------|
| CF-3200 | 32W | 2700L/H | 3 | × | ✓ | 300-800L | Ø23 | 33×33×47cm | 43.5×33.5×34cm | 2/1 | 10.0kg |
| CF-3400 | 32W | 2700L/H | 4 | × | ✓ | 300-900L | Ø23 | 33×33×54cm | 43.5×33.5×40cm | 2/1 | 10.9kg |
| UF-3200 | 40W | 2700L/H | 3 | ✓ | × | 300-800L | Ø23 | 33×33×47cm | 50×38×40.5cm | 2/1 | 14.5kg |
| UF-3400 | 40W | 2700L/H | 4 | ✓ | × | 300-900L | Ø23 | 33×33×54cm | 50×38×47.8cm | 2/1 | 15.6kg |

EF池/缸过滤桶 EF POND/TANK CANISTER FILTER

- 适用于池塘，大型鱼缸过滤。
- 超大容量，滤材自由配。
- 有自动清洗滤材功能。
- 产品无动力，需连接水泵使用。

- Suitable for ponds and big fish tank.
- Super capacity, free matching of filter materials.
- Filter materials can be cleaned automatically.
- The product has no power, it needs to be connected to the water pump for use.



110~120V 60Hz / 220~240V 50Hz

| 型号 Model | 适用水泵 Suit For Water Pump | 出入口 In. Out | UV灯功率 UVC Power | 容量 Capacity | 过滤高度 Filter Height | 纸箱尺寸 Carton size | 个/件 pcs/ctn | 重量 Weight |
|------------|--------------------------|-------------|-----------------|-------------|--------------------|------------------|-------------|-----------|
| EF-3000 | 3000-5000 | 1.25" | / | 15.5L | 25cm | 79.5×42×39.5cm | 2/1 | 12.2kg |
| EF-3000uvc | 3000-5000 | 1.25" | 5W | 15.5L | 25cm | 79.5×42×39.5cm | 2/1 | 12.2kg |
| EF-4000 | 5000-8000 | 1.25" | / | 21.5L | 35cm | 79.5×42×49.5cm | 2/1 | 15.0kg |
| EF-4000uvc | 5000-8000 | 1.25" | 9W | 21.5L | 35cm | 79.5×42×49.5cm | 2/1 | 15.0kg |
| EF-5000 | 8000-13000 | 1.5" | / | 27.5L | 45cm | 79.5×42×59.5cm | 2/1 | 10.7kg |
| EF-5000uvc | 8000-13000 | 1.5" | 9W | 27.5L | 45cm | 79.5×42×59.5cm | 2/1 | 10.7kg |
| EF-6000 | 10000-15000 | 1.5" | / | 33.5L | 55cm | 79.5×42×69.5cm | 2/1 | 10.0kg |
| EF-6000uvc | 10000-15000 | 1.5" | 9W | 33.5L | 55cm | 79.5×42×69.5cm | 2/1 | 10.0kg |

| 轮换类配件 Rotation parts | |
|----------------------|------------|
| 编码 Code | 过滤绵 Sponge |
| 型号 Model | |
| EF-3000 | |
| EF-3000uvc | GY20025 |
| EF-4000 | |
| EF-4000uvc | GY20029 |
| EF-5000 | |
| EF-5000uvc | GY20024 |
| EF-6000 | |
| EF-6000uvc | GY20023 |

3个月更换 3 months replacement

NEW QZ前置过滤器 QZ PREFILTER



- 前置过滤器预先过滤杂质，有效延长滤桶清洗周期。
- 产品无动力，需连接过滤桶或水泵使用。
- 密封防漏，清洗简便。
- Prefilter can remove the impurities in advance and extend the cleaning cycle of the canister filter.
- The product has no power, it needs to be connected to the canister filter or water pump for use.
- Leak-proof, easy to clean.

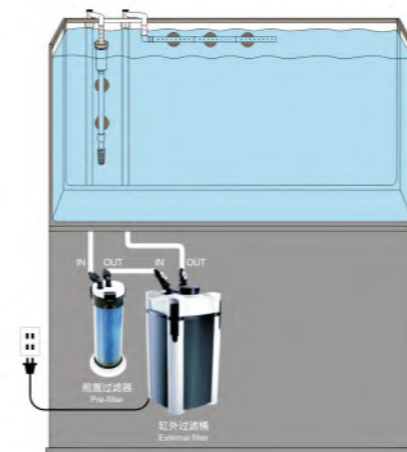

| 消耗类配件 Consumption parts | | 轮换类配件 Rotation class parts | |
|-------------------------|------------|----------------------------|--|
| 转接头 Adapter | 过滤绵 Sponge | | |
| Φ12mm | | | |
| | Φ16mm | | |
| FS30001 | FS30103 | | |

3个月更换 3 months replacement

| 型号 Model | 纸箱尺寸 Carton size | 件/箱 pcs/ctn | 重量 Weight |
|----------|------------------|-------------|-----------|
| QZ-30 | 58×44×38cm | 12/1 | 9.6kg |



Q7 外挂过滤桶 Q7 BACK HANG CANISTER FILTER

- 电机安装在滤桶内，一体成型。
- 加厚塑料，结实耐用，静音防漏。
- 滤材自由搭配，带除油膜器，UV杀菌灯。
- 通用有/无边框鱼缸，淡/海水适用。

- Motor is installed inside, integrated molding.
- Thick plastic, durable, ultra quiet and leak-proof design.
- Filter materials can be customized, using surface skimmer and UV lamp to optimize filtering effect.
- Suitable for any aquarium and can be used in freshwater and marine water.

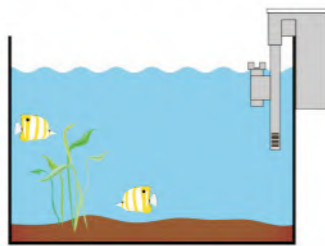

| 消耗类配件 Consumption parts | | 轮换类配件 Rotation parts | |
|-------------------------|-------------|----------------------|-----------------|
| 编码 Code | 转子 Impeller | 杀菌灯 UV Lamp | 过滤棉 Sponge |
| 型号 Model | | | 活性炭盒 Carbon box |
| Q7-M | FS30093 | FS30093 | FS30078 |
| Q7-Muv | | | FS30079 |
| Q7-L | FS30104 | | FS30105 |
| Q7-Luv | | | FS30106 |

3个月更换 3 months replacement

110~120V 60Hz / 220~240V 50Hz

| 型号 Model | UV灯 UV lamp | 功率 Power | 流量 Water flow | 适用鱼缸 Suit for aquarium | 产品尺寸 Product size | 过滤盒 Filter box | 纸箱尺寸 Carton size | 件/箱 pcs/ctn | 重量 Weight |
|----------|-------------|----------|---------------|------------------------|-------------------|----------------|------------------|-------------|-----------|
| Q7-M | ☑ | 8W | 850L/H | 50-80cm/50-150L | 12×24.5×25cm | 2个 | 52×39×54cm | 12/1 | 16.2kg |
| Q7-Muv | | 7W | 850L/H | 50-80cm/50-150L | 12×24.5×25cm | 2个 | 52×39×54cm | 12/1 | 18.6kg |
| Q7-L | ☑ | 10W | 1100L/H | 70-100cm/140-230L | 31×14×30.8cm | 3个 | 66×46×34cm | 6/1 | 15.6kg |
| Q7-Luv | | 9W | 1100L/H | 70-100cm/140-230L | 31×14×30.8cm | 3个 | 66×46×34cm | 6/1 | 16.8kg |

SP缸内背挂过滤器 SP BACK HANGING FILTER

颜色 COLOR

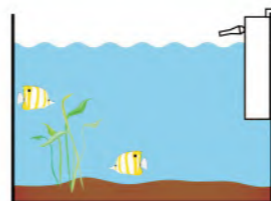

- 采用节能电机，高效低噪。
- 优质滤材搭配，清洗更换简便。
- 内置加热棒槽，可装加热棒。
- Energy saving motor, high efficiency and low noise.
- High quality filter materials matching, easy replacement.
- Built-in heater bin, heater can be installed.



| 轮换类配件 Rotation parts | | | | | | 消耗类配件 Consumption parts | |
|----------------------|---------------------------|---------------------------|-----------------|------------|-----------------|-------------------------|---------|
| 型号 Model | SP-100 | SP-200 | SP-500 | SP-800 | | 转子 Impeller | 编码 Code |
| 滤材 Filter material | 滤材套装 Filter material suit | 滤材套装 Filter material suit | 活性炭盒 Carbon box | 过滤棉 Sponge | 活性炭盒 Carbon box | 过滤棉 Sponge | |
| 编码 Code | FS30019 | FS30019 | FS30086 | FS30094 | FS30082 | FS30095 | |

3个月更换 3 months replacement

110~120V 60Hz / 220~240V 50Hz

| 型号 Model | 功率 Power | 最大流量 Q Max | 适用鱼缸 Applicable | 适用玻璃 Suitable glass | 产品尺寸 Product size | 纸箱尺寸 Carton size | 件/箱 pcs/ctn | 重量 Weight |
|----------|----------|------------|-----------------|---------------------|-------------------|------------------|-------------|-----------|
| SP-100 | 2w | 100L/h | 10-20cm/5-20L | ≤ 4mm | 11×3.5×12cm | | | |
| SP-200 | 2.5w | 200L/h | 20-40cm/10-30L | ≤ 5mm | 14.5×4×19cm | 51×30×33cm | 16/1 | 11.0kg |
| SP-500 | 4w | 350L/h | 30-50cm/25-50L | ≤ 6mm | 20×5×23cm | 47×30×44cm | 12/1 | 11.8kg |
| SP-800 | 5w | 450L/h | 50-80cm/50-120L | ≤ 6mm | 26×5×23cm | 54×54×30cm | 14/1 | 17.5kg |



HK 外挂过滤盒 HK BACK HANGING FILTER

- 电机安装于滤盒内，一体成型，防漏静音。
- 可按玻璃厚度裁剪卡扣，通用有/无边框鱼缸。
- 流量可调，带除油膜器，滤材更换简便。
- Perfect motor is installed inside, integrated molding, ultra quiet design.
- Buckle can be cut according to the glass thickness, suitable for any aquarium.
- Adjustable flow of rate, using surface skimmer, easily to replace the filter materials.

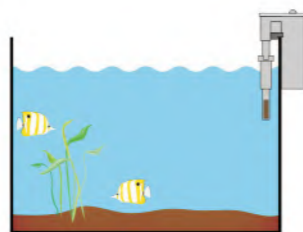

| 轮换类配件 Rotation parts | | | | | | | | 消耗类配件 Consumption parts | | |
|----------------------|-----------------|------------|-----------------|------------------|-----------------|------------------|-----------------|-------------------------|-------------|---------|
| 型号 Model | HK-0100 | | HK-0300 | | HK-0400 | | HK-0600 | | 转子 Impeller | 编码 Code |
| 滤材 Filter material | 活性炭盒 Carbon box | 过滤棉 Sponge | 活性炭盒 Carbon box | 过滤板 Filter board | 活性炭盒 Carbon box | 过滤板 Filter board | 活性炭盒 Carbon box | 过滤棉 Sponge | | |
| 编码 Code | FS30052 | FS30098 | FS30051 | FS30099 | FS30050 | FS30067 | FS30049 | FS30101 | | |

3个月更换 3 months replacement

110~120V 60Hz / 220~240V 50Hz

| 型号 Model | 功率 Power | 最大流量 Q Max | 适用鱼缸 Applicable | 可裁卡扣 Cut buckles | 产品尺寸 Product size | 纸箱尺寸 Carton size | 件/箱 pcs/ctn | 重量 Weight |
|----------|----------|------------|-----------------|------------------|-------------------|------------------|-------------|-----------|
| HK-0100 | 1.5w | 144L/H | 10-20cm/5-10L | ☑ | 8.9×7.5×12cm | 43×36×32cm | 22/1 | 8.0kg |
| HK-0300 | 2.2w | 280L/H | 20-30cm/10-20L | ☑ | 11.4×8.3×13.7cm | 48×38×33cm | 24/1 | 11.6kg |
| HK-0400 | 4.2w | 372L/H | 25-40cm/15-30L | ☑ | 14.8×9.3×16.8cm | 43×33×39cm | 16/1 | 11.1kg |
| HK-0600 | 6w | 720L/H | 35-50cm/25-50L | ☑ | 19.4×11.7×20.4cm | 52×42×49cm | 16/1 | 18.8kg |

HF-B 背挂过滤器 HF-B BACK HANGING FILTER

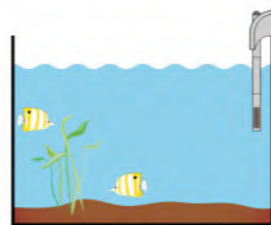

- 背挂在鱼缸上，瀑布出水。
- 节能电机高效低噪，流量可调。
- 优选滤材搭配，清洗更换简便。
- Hanging on the back of the fish tank, the waterfall comes out of the water.
- Energy saving motor has high efficiency, low noise and adjustable flow.
- Excellent filter materials matching, easy to clean and replace.



| 轮换类配件 Rotation parts | | | | 消耗类配件 Consumption parts | |
|---------------------------|----------|----------|----------|-------------------------|---------|
| 型号 Model | HF-B0200 | HF-B0300 | HF-B0300 | 转子 Impeller | 编码 Code |
| 滤材套装 Filter material suit | | | | | |
| 编码 Code | FS30055 | FS30054 | FS30053 | | |

3个月更换 3 months replacement

110~120V 60Hz / 220~240V 50Hz

| 型号 Model | 功率 Power | 流量 Q.max | 纸箱尺寸 Carton size | 件/箱 pcs/ctn | 重量 Weight |
|----------|----------|----------|------------------|-------------|-----------|
| HF-B0200 | 2.5w | 200L/h | 35×26×34cm | 12/1 | 5.6kg |
| HF-B0300 | 4w | 350L/h | 41×34.5×34cm | 12/1 | 8.6kg |
| HF-B0400 | 5w | 450L/h | 41.5×39.5×37.2cm | 12/1 | 10.5kg |



HF背挂过滤器 HF BACK HANGING FILTER

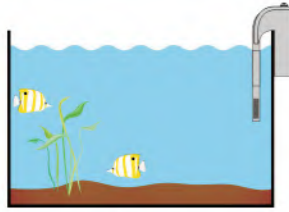

- 背挂在鱼缸上，瀑布出水。
- 节能电机高效低噪，流量可调。
- 优选滤材搭配，清洗更换简便。

- Hanging on the back of the fish tank, the waterfall comes out of the water.
- Energy saving motor has high efficiency, low noise and adjustable flow.
- Excellent filter materials matching, easy to clean and replace.

| 轮换类配件 Rotation parts | | | | | | | | | | |
|----------------------|--------------------------|---------------|--------------------|---------------------|--------------------|---------------------|--------------------|---------------------|--------------------|---------------------|
| 型号 Model | HF-0100 | | HF-0300 | | HF-0400 | | HF-0600 | | HF-0800 | |
| 滤材 Filter material | 活性炭盒 Filtering cotton | 过滤棉 Sponge | 活性炭盒 Carbon box | 过滤板 Filter board | 活性炭盒 Carbon box | 过滤板 Filter board | 活性炭盒 Carbon box | 过滤板 Filter board | 活性炭盒 Carbon box | 过滤板 Filter board |
| 编码 Code | FS30052 | FS30097 | FS30062 | FS30056 | FS30066 | FS30067 | FS30074 | FS30075 | FS30069 | FS30096 |

| 消耗类配件 Consumption parts | |
|-------------------------|---------|
| 型号 Model | 编码 Code |
| 转子 Impeller | FS30057 |
| HF-0100 | FS30057 |
| HF-0300 | FS30060 |
| HF-0400 | FS30064 |
| HF-0600 | FS30071 |
| HF-0800 | FS30059 |

110~120V 60Hz / 220~240V 50Hz

| 型号 Model | 功率 Power | 流量 Q.max | 纸箱尺寸 Carton size | 件/箱 pcs/ctn | 重量 Weight |
|----------|----------|----------|------------------|-------------|-----------|
| HF-0100 | 3w | 190L/h | 38×27.5×41.3cm | 24/1 | 8.6kg |
| HF-0300 | 3w | 290L/h | 34.8×33.2×33.6cm | 12/1 | 6.9kg |
| HF-0400 | 3.5w | 350L/h | 34.8×33.2×37.6cm | 12/1 | 9.2kg |
| HF-0600 | 6w | 660L/h | 48.3×43×44.5cm | 12/1 | 16.0kg |
| HF-0800 | 8.5w | 900L/h | 50×37.5×45.5cm | 6/1 | 11.7kg |



AT内置过滤器 AT INTERNAL FILTER

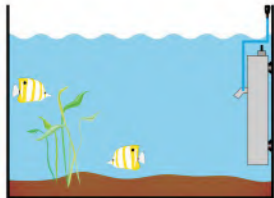

- 出水口带进气孔，滤水同时增氧。
- 大滤材容量，按需求配置不同滤材。
- 带加热棒槽，可添置加热棒。
- The water outlet has an air inlet, can filter water and increase oxygen.
- Large filter material capacity, different filter materials shall be configured according to the demand.
- With heater bin, heater can be added.



110~120V 60Hz / 220~240V 50Hz

| 型号 Model | 功率 Power | 最大流量 Q Max | 纸箱尺寸 Carton size | 件/箱 pcs/ctn | 重量 Weight |
|----------|----------|------------|------------------|-------------|-----------|
| AT-881 | 6w | 600L/H | 53.6×24.2×45.7cm | 12/1 | 15.2kg |
| AT-882 | 13w | 1056L/H | 43.5×38.8×58.6cm | 8/1 | 22.0kg |
| AT-883 | 22w | 1500L/H | 44.3×35.2×47.8cm | 4/1 | 15.4kg |

NEW NZ内置过滤器 NZ INTERNAL FILTER

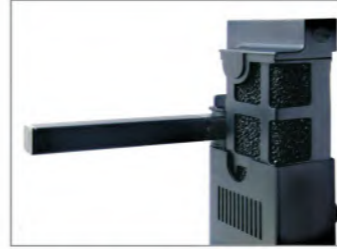

- 采用吸盘式安装，可以直立或横放。
- 过滤棉搭配活性炭盒，带UV灯，滤水同时杀菌。
- 带水量阀，流量可调，滤材更换方便。
- Installed by suction cup and can be placed vertically or horizontally.
- Using sponge match with activated carbon box and UV lamp, sterilizing when filtered the water.
- With water valve, adjustable flow, easy to clean and replace filter materials.

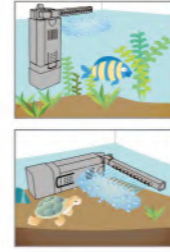

| 型号 Model | 消耗类配件 Consumption class parts | | | 轮换类配件 Rotation class parts | |
|-------------|-------------------------------|-------------|------------|----------------------------|--|
| | 转子 Impeller | 杀菌灯 UV Lamp | 过滤棉 Sponge | 活性炭盒 Carbon box | |
| NZ-1 | FS30089 | / | FS30027 | FS30090 | |
| NZ-2 | FS30091 | / | FS30026 | FS30092 | |
| NZ-3 | FS30047 | / | FS30025 | FS30042 | |
| NZ-4 NZ-4uv | FS30040 | UV60021 | FS30024 | FS30035 | |
| NZ-5 NZ-5uv | FS30033 | UV60006 | FS30023 | FS30028 | |

110~120V 60Hz / 220~240V 50Hz

| 型号 Model | 功率 Power | UV灯 UV | 最大流量 Q Max | 适用鱼缸 Applicable | 产品尺寸 Product size | 纸箱尺寸 Carton size | 件/箱 pcs/ctn | 重量 Weight |
|----------|----------|--------|------------|-----------------|-------------------|------------------|-------------|-----------|
| NZ-1 | 2.5W | / | 240L/h | 10-30cm/5-20L | 5.5x4x16cm | 38×37×37cm | 56/1 | 16.4kg |
| NZ-2 | 7W | / | 420L/h | 20-40cm/10-30L | 6.5x4.5x18cm | 41×35×41cm | 48/1 | 21.3kg |
| NZ-3 | 11W | / | 720L/h | 30-50cm/20-40L | 7.5x5.5x23cm | 44×41×27.5cm | 24/1 | 15.9kg |
| NZ-4 | 11W | / | 870L/h | 50-60cm/40-90L | 10x6.5x24cm | 58×42×44cm | 30/1 | 15.7kg |
| NZ-5 | 11W | / | 870L/h | 50-60cm/40-90L | 10x6.5x31cm | 58×42×36cm | 20/1 | 20.2kg |
| NZ-4UV | 11W | 7W | 800L/h | 50-80cm/40-120L | 10x6.5x24cm | 58×42×44cm | 30/1 | 27.8kg |
| NZ-5UV | 11W | 7W | 800L/h | 50-80cm/40-120L | 10x6.5x31cm | 58×42×36cm | 20/1 | 20.2kg |



NEW SKF三角过滤器 SKF CORNER FILTER

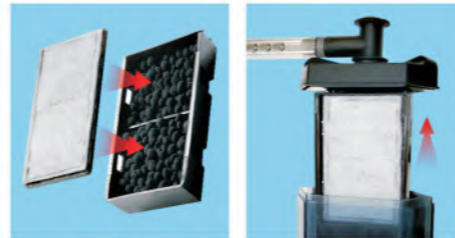

- 采用吸盘式安装，可以直立或横放。
- 滤材盒集成过滤棉和活性炭，更换方便。
- 带水量阀，流量可调。
- Installed by suction cup and can be placed vertically or horizontally.
- Filter material box includes sponge and activated carbon, easy to replace.
- With water valve, adjustable flow.



| 型号 Model | 消耗类配件 Consumption class parts | | 轮换类配件 Rotation class parts | |
|----------|-------------------------------|---------------|----------------------------|--|
| | 转子 Impeller | 碳盒 Carbon box | | |
| SKF-200 | WP10092 | FS30014 | | |
| SKF-300 | | | | |

110~120V 60Hz / 220~240V 50Hz

| 型号 Model | 功率 Power | 最大流量 Q Max | 适用鱼缸 Applicable | 产品尺寸 Product size | 纸箱尺寸 Carton size | 件/箱 pcs/ctn | 重量 Weight |
|----------|----------|------------|-----------------|-------------------|------------------|-------------|-----------|
| SKF-200 | 2.5W | 300L/h | 20-40cm | 7.4x4.9x16.9cm | 58.5×35.5×25cm | 20/1 | 7.9kg |
| SKF-300 | 2.5W | 300L/h | 20-50cm | 7.4x4.9x24.4cm | 58.5×35.5×32.5cm | 20/1 | 10.2kg |



SKF-200 SKF-300

AT-F100内置过滤器 AT-F100 INTERNAL FILTER

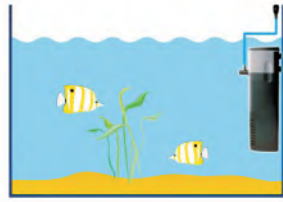

- 具备运水过滤和进气功能。
- 节能电机搭配耐磨转子，高效低噪。
- 内置过滤棉，过滤效果好。
- 吸盘式安装，拆洗便捷。

- It has filtration and air intake functions.
- Energy saving motor with wear-resistant impeller, high efficiency and low noise.
- Built-in sponge, filtering effect is good.
- Installed by suction cup, easy to clean.

110~120V 60Hz / 220~240V 50Hz

| 型号 Model | 功率 Power | 流量 Q.max | 扬程 H.max | 过滤盒 Filter box | 纸箱尺寸 Carton size | 件/箱 pcs/ctn | 重量 Weight |
|-------------|-------------|-------------|-------------|-------------------|---------------------|----------------|--------------|
| AT-F101 | 5w | 350L/h | 0.6m | 1 | 38.6×37.2×42.3cm | 48/1 | 15.5kg |
| AT-F102 | 8w | 500L/h | 1.05m | 2 | 41.7×26.8×45.9cm | 24/1 | 14.8kg |
| AT-F103 | 13w | 1200L/h | 1.2m | 2 | 42.2×31.3×50.4cm | 24/1 | 21.8kg |
| AT-F104 | 28w | 2000L/h | 2m | 2 | 36.8×35.8×44.3cm | 12/1 | 17.7kg |

| 消耗类配件 Consumption class parts | 轮换类配件 Rotation class parts |
|---|---|
| 编码 Code 转子 Impeller | 编码 Code 过滤棉 Sponge |
| 型号 Model AT-F101 AT-F102 AT-F103 AT-F104 | 型号 Model WP10066 WP10064 WP10062 WP10060 |
| | WP10031 WP10030 WP10029 WP10028 |
| | 3个月更换 3 months replacement |

AT-F300内置过滤器 AT-F300 INTERNAL FILTER

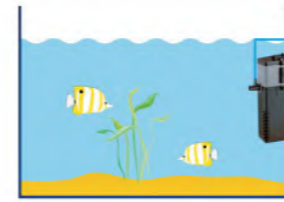

- 具备运水过滤和进气功能。
- 节能电机搭配耐磨转子，高效低噪。
- 内置过滤棉，过滤效果好。
- 吸盘式安装，拆洗便捷。

- It has filtration and air intake functions.
- Energy saving motor with wear-resistant impeller, high efficiency and low noise.
- Built-in sponge, filtering effect is good.
- Installed by suction cup, easy to clean.

110~120V 60Hz / 220~240V 50Hz

| 型号 Model | 功率 Power | 流量 Q.max | 扬程 H.max | 过滤盒 Filter box | 纸箱尺寸 Carton size | 件/箱 pcs/ctn | 重量 Weight |
|-------------|-------------|-------------|-------------|-------------------|---------------------|----------------|--------------|
| AT-F300 | 2w | 150L/h | 0.4m | 1 | 38.6×37.2×42.3cm | 48/1 | 15.5kg |
| AT-F301 | 2.5w | 230L/h | 0.5m | 1 | 41.7×26.8×45.9cm | 24/1 | 14.8kg |
| AT-F302 | 5w | 450L/h | 0.7m | 1 | 42.2×31.3×50.4cm | 24/1 | 21.8kg |
| AT-F303 | 6w | 600L/h | 0.9m | 1 | 36.8×35.8×44.3cm | 12/1 | 17.7kg |
| AT-F304 | 8w | 800L/h | 1.1m | 1 | 49.6×26.6×44.7cm | 24/1 | 16.2kg |
| AT-F305 | 13w | 1200L/h | 1.3m | 1 | 47×31.3×58.3cm | 24/1 | 21.1kg |
| AT-F306 | 27w | 2000L/h | 2m | 1 | 34.8×33.3×47.7cm | 12/1 | 15.1kg |

| 消耗类配件 Consumption class parts | 轮换类配件 Rotation class parts |
|--|--|
| 编码 Code 转子 Impeller | 编码 Code 过滤棉 Sponge |
| 型号 Model AT-F300 AT-F301 AT-F302 AT-F303 AT-F304 AT-F305 AT-F306 | 型号 Model WP10089 WP10092 WP10019 WP10045 WP10043 WP10041 WP10039 |
| | WP10093 WP10025 WP10021 WP10017 WP10016 WP10094 WP10095 |
| | 3个月更换 3 months replacement |

AT-F200内置过滤器 AT-F200 INTERNAL FILTER



- 具备运水过滤和进气功能。
- 节能电机搭配耐磨转子，高效低噪。
- 内置过滤棉，过滤效果好。
- 吸盘式安装，拆洗便捷。

- It has filtration and air intake functions.
- Energy saving motor with wear-resistant impeller, high efficiency and low noise.
- Built-in sponge, filtering effect is good.
- Installed by suction cup, easy to clean.

110~120V 60Hz / 220~240V 50Hz

| 型号 Model | 功率 Power | 流量 Q.max | 扬程 H.max | 过滤盒 Filter box | 纸箱尺寸 Carton size | 件/箱 pcs/ctn | 重量 Weight |
|-------------|-------------|-------------|-------------|-------------------|---------------------|----------------|--------------|
| AT-F201 | 9w | 650L/h | 0.9m | 2 | 49.6×26.6×44.7cm | 24/1 | 16.2kg |
| AT-F202 | 12w | 1200L/h | 1.3m | 2 | 47×31.3×58.3cm | 24/1 | 21.1kg |
| AT-F203 | 32w | 2000L/h | 2m | 2 | 34.8×33.3×47.7cm | 12/1 | 15.1kg |

| 消耗类配件 Consumption class parts | 轮换类配件 Rotation class parts |
|--|--|
| 编码 Code 转子 Impeller | 编码 Code 过滤棉 Sponge |
| 型号 Model AT-F201 AT-F202 AT-F203 | 型号 Model WP10051 WP10049 WP10047 |
| | WP10029 WP10091 WP10028 |
| | 3个月更换 3 months replacement |

PF内置过滤器 PF INTERNAL FILTER



- 具备运水过滤和进气功能。
- 节能电机搭配耐磨转子，高效低噪。
- 内置过滤棉，过滤效果好。
- 吸盘式安装，拆洗便捷。

- It has filtration and air intake functions.
- Energy saving motor with wear-resistant impeller, high efficiency and low noise.
- Built-in sponge, filtering effect is good.
- Installed by suction cup, easy to clean.

110~120V 60Hz / 220~240V 50Hz

| 型号 Model | 功率 Power | 流量 Q.max | 扬程 H.max | 过滤盒 Filter box | 纸箱尺寸 Carton size | 件/箱 pcs/ctn | 重量 Weight |
|-------------|-------------|-------------|-------------|-------------------|---------------------|----------------|--------------|
| PF-200 | 6w | 360L/h | 0.8m | 2 | 36×34.3×38cm | 48/1 | 12.3kg |
| PF-400 | 8w | 600L/h | 0.85m | 2 | 38×37.5×32.2cm | 30/1 | 13.6kg |
| PF-500 | 9w | 730L/h | 0.98m | 2 | 43.2×36.8×33.2cm | 30/1 | 16.3kg |
| PF-1100 | 15w | 1100L/h | 1.4m | 2 | 63×30×48.8cm | 24/1 | 20.4kg |
| PF-2000 | 35w | 2200L/h | 2.2m | 2 | 46×31.5×38cm | 12/1 | 17.7kg |
| PF-2500 | 45w | 2500L/h | 2.25m | 2 | 50×37.5×41.3cm | 12/1 | 24.4kg |
| PF-3500 | 72w | 3500L/h | 2.9m | 2 | 40.5×39×28.4cm | 6/1 | 16.5kg |

| 消耗类配件 Consumption class parts | 轮换类配件 Rotation class parts |
|---|--|
| 编码 Code 转子 Impeller | 编码 Code 过滤棉 Sponge |
| 型号 Model PF-200 PF-400 PF-500 PF-1100 PF-2000 PF-2500 PF-3500 | 型号 Model WP10083 WP10045 WP10043 WP10012 WP10009 WP10086 WP10006 |
| | WP10096 WP10097 WP10098 WP10099 WP10100 WP10101 WP10102 |
| | 3个月更换 3 months replacement |

AT-1000/1500/2500内置过滤器 AT-1000/1500/2500 INTERNAL FILTER



- 具备运水过滤和进气功能。
- 节能电机搭配耐磨转子，高效低噪。
- 多个滤盒，内置过滤棉，过滤效果好。
- 吸盘式安装，拆洗便捷。
- It has filtration and air intake functions.
- Energy saving motor with wear-resistant impeller, high efficiency and low noise.
- Multiple filter boxes, built-in sponge, filtering effect is good.
- Installed by suction cup, easy to clean.

110~120V 60Hz / 220~240V 50Hz

| 型号 Model | 功率 Power | 流量 Q.max | 过滤盒 Filter box | 纸箱尺寸 Carton size | 件/箱 pcs/ctn | 重量 Weight |
|-------------|-------------|-------------|-------------------|---------------------|----------------|--------------|
| AT-1000A | 15w | 1000L/h | 0 | 42.4×33.7×46.6cm | 36/1 | 13.8kg |
| AT-1000AF | 15w | 1000L/h | 1 | 42.3×41.8×39.5cm | 30/1 | 12.9kg |
| AT-1000BF | 15w | 1000L/h | 2 | 49.8×41.6×39.5cm | 30/1 | 13.8kg |
| AT-1000CF | 15w | 1000L/h | 3 | 50×33.5×45.3cm | 24/1 | 11.9kg |
| AT-1500A | 26w | 1500L/h | 0 | 45.5×35.5×33.5cm | 24/1 | 11.8kg |
| AT-1500BF | 26w | 1500L/h | 2 | 52.8×36×42.6cm | 24/1 | 13.4kg |
| AT-1500CF | 26w | 1500L/h | 3 | 52.8×36×42.6cm | 24/1 | 13.4kg |
| AT-1500DF | 26w | 1500L/h | 4 | 53×35.8×26.9cm | 12/1 | 12.2kg |
| AT-2500A | 40w | 2500L/h | 0 | 45.5×36×36.5cm | 24/1 | 22kg |
| AT-2500CF | 40w | 2500L/h | 3 | 35.8×35.6×43.1cm | 16/1 | 10.4kg |
| AT-2500DF | 40w | 2500L/h | 4 | 53.1×36×28.5cm | 12/1 | 5.6kg |

SIF内置过滤器 SIF INTERNAL FILTER



- 吸盘式安装，过滤水体，拆洗便捷。
- 节能电机搭配耐磨转子，高效低噪。
- 多个滤盒，内置过滤棉，过滤效果好。

- Installed by suction cup, filter water, easy to clean.
- Energy saving motor with wear-resistant impeller, high efficiency and low noise.
- Multiple filter boxes, built-in sponge, filtering effect is good.

110~120V 60Hz / 220~240V 50Hz

| 型号 Model | 功率 Power | 流量 Q.max | 过滤盒 Filter box | 纸箱尺寸 Carton size | 件/箱 pcs/ctn | 重量 Weight |
|-------------|-------------|-------------|-------------------|---------------------|----------------|--------------|
| SIF-400 | 4.2w | 168L/h | 2 | 40×34.5×40.8cm | 24/1 | 13.2kg |
| SIF-500 | 4.2w | 168L/h | 3 | 50×34.5×26.3cm | 15/1 | 9.2kg |
| SIF-600 | 4.2w | 168L/h | 4 | 50×34.5×31cm | 15/1 | 10.9kg |
| SIF-700 | 7.4w | 400L/h | 2 | 55×38.5×30cm | 15/1 | 14.4kg |
| SIF-800 | 7.4w | 400L/h | 3 | 55×38.5×37cm | 15/1 | 15.2kg |
| SIF-900 | 7.4w | 400L/h | 4 | 55×38.5×44cm | 15/1 | 19.0kg |

| 消耗类配件 Consumption class parts | 轮换类配件 Rotation class parts |
|---|--|
| 转码 Code 转子 Impeller | 过码 Code 过滤棉 Sponge |
| 型号 Model SIF-400 SIF-500 SIF-600 SIF-700 SIF-800 SIF-900 | FS30016 FS30022 FS30017 FS30021 |

3个月更换 3 months replacement

TSF三角过滤器 TSF CORNER FILTER



- 吸盘式安装，过滤水体，拆洗便捷。
- 节能电机搭配耐磨转子，高效低噪。
- 多个滤盒，内置过滤棉，过滤效果好。

- Installed by suction cup, filter water, easy to clean.
- Energy saving motor with wear-resistant impeller, high efficiency and low noise.
- Multiple filter boxes, built-in sponge, filtering effect is good.

110~120V 60Hz / 220~240V 50Hz

| 型号 Model | 功率 Power | 流量 Q.max | 过滤盒 Filter box | 纸箱尺寸 Carton size | 件/箱 pcs/ctn | 重量 Weight |
|-------------|-------------|-------------|-------------------|---------------------|----------------|--------------|
| TSF-200 | 4.8w | 240L/h | 3 | 33.5×29.2×40.4cm | 12 | 12 |
| TSF-450 | 8.8w | 650L/h | 3 | 44.5×40.5×30.8cm | 15 | 15 |
| TSF-1000 | 15.5w | 1150L/h | 3 | 44×34.5×38.5cm | 8 | 8 |

| 消耗类配件 Consumption class parts | 轮换类配件 Rotation class parts |
|---|--|
| 转码 Code 转子 Impeller | 过码 Code 过滤棉 Sponge |
| 型号 Model TSF-200 TSF-450 TSF-1000 | FS30008 FS30005 FS30011 FS30010 FS30007 FS30013 |

3个月更换 3 months replacement

AT内置过滤器 AT INTERNAL FILTER

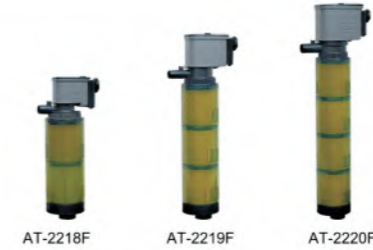

- 吸盘式安装，过滤水体，拆洗便捷。
- 节能电机搭配耐磨转子，高效低噪。
- 多个滤盒，内置过滤棉，过滤效果好。

- Installed by suction cup, filter water, easy to clean.
- Energy saving motor with wear-resistant impeller, high efficiency and low noise.
- Multiple filter boxes, built-in sponge, filtering effect is good.

110~120V 60Hz / 220~240V 50Hz

| 型号 Model | 功率 Power | 流量 Q.max | 过滤盒 Filter box | 纸箱尺寸 Carton size | 件/箱 pcs/ctn | 重量 Weight |
|-------------|-------------|-------------|-------------------|---------------------|----------------|--------------|
| AT-2218F | 9w | 650L/h | 2 | 47×31.3×58.3cm | 24/1 | 21.1kg |
| AT-2219F | 12w | 1200L/h | 3 | 48.3×37.3×52.8cm | 24/1 | 20.3kg |
| AT-2220F | 32w | 1800L/h | 4 | 45.9×32.5×44.1cm | 12/1 | 15.8kg |

| 消耗类配件 Consumption class parts | 轮换类配件 Rotation class parts |
|---|--|
| 转码 Code 转子 Impeller | 过码 Code 过滤棉 Sponge |
| 型号 Model AT-2218F AT-2219F AT-2220F | WP10051 WP10049 WP10047 WP10103 |

3个月更换 3 months replacement

NEW RX可控变频造浪泵

FREQUENCY CONVERSION WAVE MAKER PUMP



- 采用无刷伺服变频电机，节能低噪，动力强劲。
- 无线联动功能，实现多台交互工作。
- 强磁吸盘安装，造浪角度360°可调。
- 带控制盒，5种造浪模式，6档流量调节，10分钟喂食暂停。

- It adopts the brushless servo variable frequency motor, energy saving, low noise and powerful.
- Wireless linkage function, several pumps can be operated by one smart controller.
- Use the strong magnetic suction cup to install, full 360 degree rotation for wave direction.
- With the controller, 5 wave modes, 6 levels of water flow and 10 minutes feed mode.

输入Input: 100~240V/50~60Hz 输出Output: DC24V

| 型号 Model | 功率 Power | 流量 Q.max | 产品尺寸 Product size | 可调 Adjustable | 纸箱尺寸 Carton size | 件/箱 Pcs/Ctn | 重量 Weight | 适合玻璃 Suitable glass |
|----------|----------|----------|-------------------|---------------|------------------|-------------|-----------|---------------------|
| RX-40 | 10w | 4000L/h | Φ6x8.5cm | ✓ | 38×38×40cm | 24/1 | 16.9kg | ≤12 |
| RX-80 | 22w | 8000L/h | Φ7.5x11cm | ✓ | 46×38×40cm | 24/1 | 21.6kg | ≤12 |
| RX-120 | 33w | 13000L/h | Φ9x12.5cm | ✓ | 46×44×31cm | 18/1 | 22.7kg | ≤19 |
| RX-160 | 55w | 20000L/h | Φ10.5x14cm | ✓ | 46×37×39cm | 12/1 | 20.5kg | ≤19 |

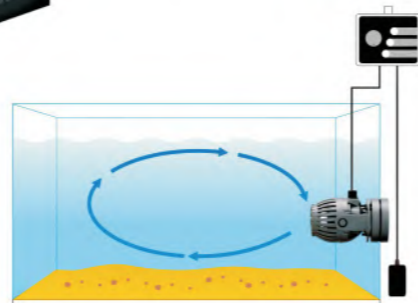

| 消耗类配件 Consumption parts | | |
|-------------------------|-------------|----------------|
| 编码 Code | 转子 Impeller | 控制盒 Controller |
| 型号 Model | | |
| RX-40 | YB80047 | YB80046 |
| RX-80 | YB80048 | |
| RX-120 | YB80049 | |
| RX-160 | YB80050 | |

NEW PX可控变频横流泵

FREQUENCY CONVERSION WAVE MAKER PUMP



- 无刷伺服变频电机，节能低噪，动力强劲，横流造浪水流均匀。
- 无线联动功能，实现多台泵交互工作。
- 强磁吸盘安装，出水口可左右调节方向。
- 带控制盒，5种造浪模式，6档流量调节，10分钟喂食暂停。

- It adopts the brushless servo variable frequency motor, energy saving, low noise and powerful, horizontal wave making flow is uniform.
- Wireless linkage function, several pumps can be operated by one smart controller.
- Use the strong magnetic suction cup to install, the water outlet can be adjusted to the right or left.
- With the controller, 5 wave modes, 6 levels of water flow and 10 minutes feed mode.

输入Input: 100~240V/50~60Hz 输出Output: DC24V

| 型号 Model | 功率 Power | 产品尺寸 Product size | 可调 Adjustable | 适合玻璃 Suitable glass | 适用鱼缸 Suitable fish tank | 纸箱尺寸 Carton size | 件/箱 Pcs/Ctn |
|----------|----------|-------------------|---------------|---------------------|-------------------------|------------------|-------------|
| PX-10 | 25w | 30x8.5x5.5cm | ✓ | 12mm≤ | 0.6~1.2m | 45×34×38cm | 10/1 |
| PX-20 | 45w | 31.5x9x6cm | ✓ | 15mm≤ | 1.2~2m | 45×34×38cm | 10/1 |
| PX-30 | 55w | 35x9.5x6.5cm | ✓ | 19mm≤ | 1.5~2.5m | 45×38×38cm | 10/1 |

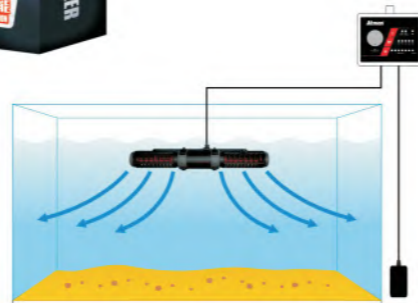

| 消耗类配件 Consumption parts | | |
|-------------------------|-------------|----------------|
| 编码 Code | 转子 Impeller | 控制盒 Controller |
| 型号 Model | | |
| PX-10 | YB80032 | YB80033 |
| PX-20 | YB80034 | YB80035 |
| PX-30 | YB80036 | YB80037 |

NEW BX兴波造浪泵

BX WAVE MAKER PUMP



- 吸盘式安装，通用各种鱼缸。
- 造浪角度360°可调。
- 螺旋桨水叶，流量大。
- Use the suction cup to install, suitable for all kinds of aquarium tanks.
- Full 360 degree rotation for wave direction.
- Use propeller blades, large flow.

| 消耗类配件 Consumption parts | | | | |
|-------------------------|----------|---------|---------|----------|
| 转子 Impeller | 型号 Model | BX-2500 | BX-5000 | BX-10000 |
| | 编码 Code | WP10067 | WP10068 | WP10069 |

110~120V 60Hz / 220~240V 50Hz

| 型号 Model | 功率 Power | 流量 Q.max | 产品尺寸 Product size | 纸箱尺寸 Carton size | 件/箱 pcs/ctn | 重量 Weight |
|----------|----------|----------|-------------------|------------------|-------------|-----------|
| BX-2500 | 2.5w | 2500L/h | Φ5.6x7.5cm | 39.5×36×38cm | 48/1 | 11.8kg |
| BX-5000 | 5w | 5000L/h | Φ7x9.5cm | 42.5×32×35cm | 36/1 | 12.6kg |
| BX-10000 | 10w | 10000L/h | Φ9.3x12.5cm | 42×35×35cm | 24/1 | 13.5kg |

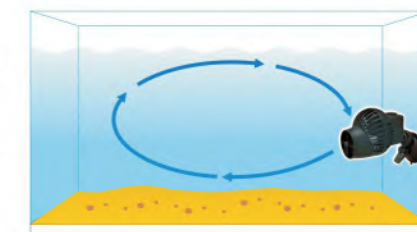

NEW MX变频水泵

MX VARIABLE FREQUENCY PUMP



MX-100S

- 采用无刷伺服变频技术，状态转换灵活，稳顺，低噪。
- 设有防堵转保护、过热保护，防漏电低压输出。
- 采用陶瓷轴转子，适用淡/海水，水陆两用。
- 控制盒设置流量和扬程，有10分钟暂停喂食功能。
- The frequency conversion technology of brushless servo is adopted, state transition is flexible, stable and low noise.
- Equipped with anti-blocking protection, overheat protection, anti-leakage, low voltage output.
- Use the ceramic impeller, suitable for freshwater and marine water, amphibious pump.
- The controller can adjust the flow and the lift, with 10 minutes feed mode.

| 消耗类配件 Consumption parts | | | |
|-------------------------|-------------|-----------------|----------------|
| 编码 Code | 转子 Impeller | 配件包 Spare parts | 控制盒 Controller |
| 型号 Model | | | |
| MX-10 / MX-10S | YB80059 | YB80054 | YB80058 |
| MX-20 / MX-20S | YB80051 | | |
| MX-40 / MX-40S | YB80052 | YB80055 | YB80057 |
| MX-60 / MX-60S | YB80053 | | |
| MX-100S | YB80027 | YB80056 | |

带控制盒 With control box Input: AC 110~240V 50/60Hz Output: DC 24V

| 型号 Model | 功率 Power | 流量 Q.max | 扬程 H.max | 产品尺寸 Product size | 纸箱尺寸 Carton size | 件/箱 pcs/ctn | 重量 Weight |
|----------|----------|----------|----------|-------------------|------------------|-------------|-----------|
| MX-10S | 10.5w | 1100L/h | 1.7m | 11.6×6.5×9.3cm | 44×32×35cm | 18/1 | 15.3kg |
| MX-20S | 21w | 1950L/h | 2.4m | 12.5×6.5×10cm | 44×32×35cm | 18/1 | 16.2kg |
| MX-40S | 30w | 4000L/h | 3.5m | 17.5×8.8×11.5cm | 52×44×41cm | 18/1 | 23.4kg |
| MX-60S | 50w | 6000L/h | 4.8m | 18×8.8×12cm | 52×44×41cm | 18/1 | 27.0kg |
| MX-100S | 110w | 12000L/h | 8.0m | 20×10.5×13.9cm | 51×44×45.5cm | 6/1 | 18.3kg |

无控制盒 Without control box Input: AC 110~240V 50/60Hz Output: DC 24V

| 型号 Model | 功率 Power | 流量 Q.max | 扬程 H.max | 产品尺寸 Product size | 纸箱尺寸 Carton size | 件/箱 pcs/ctn | 重量 Weight |
|----------|----------|----------|----------|-------------------|------------------|-------------|-----------|
| MX-10 | 10.5w | 1100L/h | 1.7m | 11.6×6.5×9.3cm | 44×30×35cm | 18/1 | 13.9kg |
| MX-20 | 21w | 1950L/h | 2.4m | 12.5×6.5×10cm | 44×30×35cm | 18/1 | 14.6kg |
| MX-40 | 30w | 4000L/h | 3.5m | 17.5×8.8×11.5cm | 50.5×32×39.5cm | 18/1 | 22.7kg |
| MX-60 | 50w | 6000L/h | 4.8m | 18×8.8×12cm | 50.5×32×39.5cm | 18/1 | 27.0kg |



NEW **AX变频水泵**
AX VARIABLE FREQUENCY PUMP



- 采用无刷伺服变频技术，状态转换灵活，稳顺，低噪。
- 电路板非环氧灌封，安装在独立仓内，维修简便。
- 采用陶瓷轴转子，适用淡/海水，水陆两用。
- 控制盒设置流量和扬程，有15/60分钟暂停喂食功能。
- The frequency conversion technology of brushless servo is adopted, state transition is flexible, stable and low noise.
- The circuit board isn't epoxy potting, is installed independently, easy to repair.
- Use the ceramic impeller, suitable for freshwater and marine water, amphibious pump.
- The controller can adjust the flow and the lift, with 15/60 minutes feed mode.

| 型号 Model | 消耗类配件 Consumption class parts | | |
|-----------------------------|-------------------------------|----------------|--------------------|
| | 编码 Code | 转子 Impeller | 配件包 Spare parts |
| AX-3000 | | | |
| FX-4000 AX-4000 | | YB80028 | AX-5000s |
| AX-5000s FX-5000 AX-5000 | | | |
| FX-6500 AX-6500 | | | YB80039 |
| FX-8000 AX-8000 | | YB80027 | |
| AX-10000s FX-10000 AX-10000 | | | AX-10000s |
| AX-12000 | | | |
| AX-15000 | | YB80029 | YB80042 |
| AX-18000 | | | YB80041 |



带控制盒

| 带控制盒 | | With control box | | | | | |
|-------------|-------------|------------------|-------------|----------------------|---------------------|----------------|--------------|
| 型号 Model | 功率 Power | 流量 Q.max | 扬程 H.max | 产品尺寸 Product size | 纸箱尺寸 Carton size | 件/箱 pcs/ctn | 重量 Weight |
| AX-5000s | 40w | 5000L/h | 3.5m | 23×10.4×13.5cm | 41×38×36cm | 6/1 | 15.7kg |
| AX-10000s | 85w | 10000L/h | 5.3m | 24.6×10.4×13.5cm | 41×38×36cm | 6/1 | 18.1kg |



无控制盒 (交流)

| 无控制盒 (交流) | | Without control box (AC) | | | | | |
|-------------|-------------|--------------------------|-------------|----------------------|---------------------|----------------|--------------|
| 型号 Model | 功率 Power | 流量 Q.max | 扬程 H.max | 产品尺寸 Product size | 纸箱尺寸 Carton size | 件/箱 pcs/ctn | 重量 Weight |
| AX-3000 | 25w | 3000L/h | 3m | 23×10.4×13.5cm | 38×33×33cm | 6/1 | 15.7kg |
| AX-4000 | 30w | 4000L/h | 3.2m | 23×10.4×13.5cm | 38×33×33cm | 6/1 | 15.7kg |
| AX-5000 | 40w | 5000L/h | 3.5m | 23×10.4×13.5cm | 38×33×33cm | 6/1 | 15.7kg |
| AX-6500 | 50w | 6500L/h | 4m | 24.6×10.4×13.5cm | 38×33×33cm | 6/1 | 18.1kg |
| AX-8000 | 65w | 8000L/h | 4.8m | 24.6×10.4×13.5cm | 38×33×33cm | 6/1 | 18.1kg |
| AX-10000 | 85w | 10000L/h | 5.3m | 24.6×10.4×13.5cm | 38×33×33cm | 6/1 | 18.1kg |
| AX-12000 | 110w | 12000L/h | 5.8m | 28.8×11.5×16cm | 37.5×28.5×40cm | 4/1 | 17.8kg |
| AX-15000 | 150w | 15000L/h | 6.2m | 28.8×11.5×16cm | 37.5×28.5×40cm | 4/1 | 17.8kg |
| AX-18000 | 180w | 18000L/h | 6.8m | 28.8×11.5×16cm | 37.5×28.5×40cm | 4/1 | 17.8kg |



无控制盒 (直流)

| 无控制盒 (直流) | | Without control box (DC) | | | | | |
|---|-------------|--------------------------|-------------|----------------------|---------------------|----------------|--------------|
| Input: AC 110~240V 50/60Hz Output: DC 24V | | | | | | | |
| 型号 Model | 功率 Power | 流量 Q.max | 扬程 H.max | 产品尺寸 Product size | 纸箱尺寸 Carton size | 件/箱 pcs/ctn | 重量 Weight |
| FX-3000 | 25w | 3000L/h | 3m | 23×10.4×13.5cm | 38×33×33cm | 6/1 | 16.3kg |
| FX-4000 | 30w | 4000L/h | 3.2m | 23×10.4×13.5cm | 38×33×33cm | 6/1 | 16.3kg |
| FX-5000 | 40w | 5000L/h | 3.5m | 23×10.4×13.5cm | 38×33×33cm | 6/1 | 16.3kg |
| FX-6500 | 50w | 6500L/h | 4m | 24.6×10.4×13.5cm | 38×33×33cm | 6/1 | 20.5kg |
| FX-8000 | 65w | 8000L/h | 4.8m | 24.6×10.4×13.5cm | 38×33×33cm | 6/1 | 21.7kg |
| FX-10000 | 85w | 10000L/h | 5.3m | 24.6×10.4×13.5cm | 38×33×33cm | 6/1 | 21.7kg |

NEW **DX变频水泵**
DX VARIABLE FREQUENCY WATER PUMP



- 无刷伺服变频电机搭配陶瓷轴转子，节能低噪，动力强劲。
- 设有无水保护、缺水保护、过载保护，过热保护、漏电保护。
- 适用于淡/海水，水陆两用。
- It adopts the technology of frequency conversion of brushless servo, energy saving, low noise and powerful.
- Equipped with no water protection, water shortage protection, overload protection, overheat protection and leakage protection.
- Use the ceramic impeller, suitable for freshwater and marine water, amphibious pump.



110~120V 60Hz / 220~240V 50Hz

| 型号 Model | 功率 Power | 流量 Q.max | 扬程 H.max | 产品尺寸 Product size | 纸箱尺寸 Carton size | 件/箱 pcs/ctn | 重量 Weight |
|-------------|-------------|-------------|-------------|----------------------|---------------------|----------------|--------------|
| DX-6 | 60w | 8000L/h | 4.5m | 21.8x9.2x16.3cm | 42×30×36cm | 6/1 | 17.8kg |
| DX-8 | 80w | 10000L/h | 5.8m | 21.8x9.2x16.3cm | 42×30×36cm | 6/1 | 17.8kg |
| DX-10 | 100w | 12000L/h | 6.5m | 21.8x9.2x16.3cm | 42×30×36cm | 6/1 | 17.9kg |

| 型号 Model | 消耗类配件 Consumption parts | |
|-------------|-------------------------|----------------|
| | 编码 Code | 转子 Impeller |
| DX-6 | | |
| DX-8 | | |
| DX-10 | YB80027 | YB80039 |

NEW **AT变频水泵**
AT VARIABLE FREQUENCY WATER PUMP

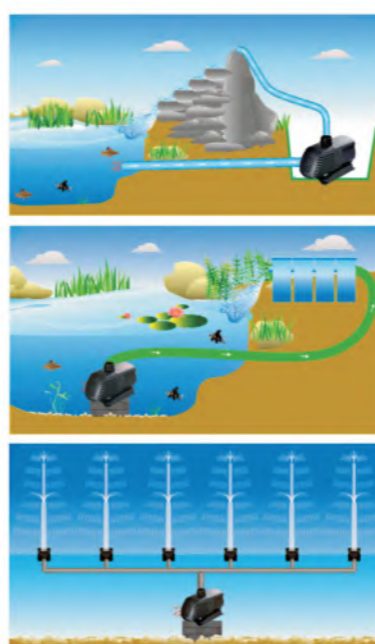

- 适合鱼缸、池塘、园林造景，抽水之用。
- 变频电机搭配陶瓷轴转子，高效低噪。
- 防漏电设计，使用安全。
- 适用于淡/海水，水陆两用。
- Suitable for aquarium tanks, water pool and water pumping.
- Variable frequency motor with the ceramic impeller, efficient and low noise.
- Anti leakage design, safe to use.
- Use the ceramic impeller, suitable for freshwater and marine water, amphibious pump.

110~120V 60Hz / 220~240V 50Hz

| 型号 Model | 功率 Power | 流量 Q.max | 扬程 H.max | 产品尺寸 Product size | 纸箱尺寸 Carton size | 件/箱 pcs/ctn | 重量 Weight |
|-------------|-------------|-------------|-------------|----------------------|---------------------|----------------|--------------|
| AT-2800 | 29w | 2800L/h | 2.3m | 18.5×9×12cm | 46×38×28cm | 12/1 | 16.7kg |
| AT-3000 | 35w | 3000L/h | 2.8m | 22.7×11×13.7cm | 38×30.5×34cm | 6/1 | 13.8kg |
| AT-4000 | 42w | 4000L/h | 2.8m | 22.7×11×13.7cm | 38×30.5×34cm | 6/1 | 13.8kg |
| AT-5000 | 55w | 5000L/h | 3m | 22.7×11×13.7cm | 38×30.5×34cm | 6/1 | 13.4kg |
| AT-6000 | 45w | 6000L/h | 3m | 26.3×12×15.3cm | 42.5×32.5×38cm | 6/1 | 18.0kg |
| AT-8000 | 65w | 8000L/h | 3.6m | 26.3×12×15.3cm | 42.5×32.5×38cm | 6/1 | 18.0kg |
| AT-10000 | 90w | 10000L/h | 4m | 26.3×12×15.3cm | 42.5×32.5×38cm | 6/1 | 18.4kg |

| 型号 Model | 消耗类配件 Consumption parts | |
|-------------|-------------------------|----------------|
| | 编码 Code | 转子 Impeller |
| AT-2800 | | |
| AT-3000 | | |
| AT-4000 | | |
| AT-5000 | | |
| AT-6000 | | |
| AT-8000 | | |
| AT-10000 | | |

MP水泵 MP WATER PUMP



- 适合大鱼缸、池塘、园林造景，抽水之用。
- 节能电机搭配陶瓷轴转子，动力强劲，大流量。
- 适用于淡/海水，水陆两用。
- Suitable for aquarium tanks, water pool, fish pond and water pumping.
- Energy saving motor with the ceramic impeller, powerful, large flow.
- Suitable for freshwater and marine water, amphibious pump.



110~120V 60Hz / 220~240V 50Hz

| 型号 Model | 功率 Power | 流量 Q.max | 产品尺寸 Product size | 纸箱尺寸 Carton size | 件/箱 Pcs/Ctn | 重量 Weight |
|-------------|-------------|-------------|----------------------|---------------------|----------------|--------------|
| MP-5500 | 60w | 5700L/h | 3m | 45.5×41×35cm | 6/1 | 18.8kg |
| MP-6500 | 85w | 6500L/h | 4m | 45.5×41×35cm | 6/1 | 19.0kg |
| MP-7500 | 125w | 7500L/h | 5m | 45.5×41×35cm | 6/1 | 19.2kg |
| MP-8500 | 155w | 8500L/h | 6m | 45.5×41×35cm | 6/1 | 19.4kg |
| MP-9500 | 170w | 9300L/h | 6.5m | 45.5×41×35cm | 6/1 | 21.0kg |
| MP-10000 | 145w | 10000L/h | 4.5m | 45.5×41×35cm | 6/1 | 21.0kg |
| MP-12000 | 110w | 10500L/h | 4m | 39×35×40cm | 4/1 | 20.0kg |
| MP-15000 | 200w | 12500L/h | 4.5m | 39×35×40cm | 4/1 | 21.3kg |
| MP-18000 | 250w | 14500L/h | 5m | 39×35×40cm | 4/1 | 22.0kg |
| MP-20000 | 320w | 16500L/h | 7m | 39×35×40cm | 4/1 | 20.4kg |

| 消耗类配件 Consumption parts | |
|-------------------------|-------------------|
| 编码 Code | 配件包 pare parts |
| 型号 Model | 转子 Impeller |
| MP-5500 | YB8008 |
| MP-6500 | YB8007 |
| MP-7500 | YB8005 |
| MP-8500 | YB8004 |
| MP-9500 | YB8002 |
| MP-10000 | YB8030 |
| MP-12000 | YB8014 |
| MP-15000 | YB8013 |
| MP-18000 | YB8012 |
| MP-20000 | YB8010 |

DP池塘泵 DP POND PUMP

- 适合大鱼缸、池塘、园林造景，抽水之用。
- 变频电机搭配陶瓷轴转子，动力强劲，大流量。
- 适用于淡/海水，水陆两用。
- Suitable for aquarium tanks, water pool, fish pond and water pumping.
- Variable frequency motor with the ceramic impeller, powerful, large flow.
- Suitable for freshwater and marine water, amphibious pump.



110~120V 60Hz / 220~240V 50Hz

| 型号 Model | 功率 Power | 流量 Q.max | 扬程 H.max |
|-------------|-------------|-------------|-------------|
| DP-3000 | 25w | 3000L/h | 3m |
| DP-4000 | 30w | 4000L/h | 3.2m |
| DP-5000 | 40w | 5000L/h | 3.5m |
| DP-6500 | 50w | 6500L/h | 4m |
| DP-8000 | 65w | 8000L/h | 4.8m |



HAX变频锦鲤池泵 HAX FREQUENCY CONVERSION KAM CARP POND PUMP

- 适合池塘，抽水之用，低水位吸水，大流量。
- 变频电机，陶瓷轴转子，稳顺低噪，高效节能。
- 设有无水保护、缺水保护、过载保护。
- Suitable for the fish pond and water pumping, low water level water absorption, large flow.
- Variable frequency motor, used ceramic impeller, energy saving, low noise and powerful.
- It has no water protection, water shortage protection and overload protection.

110~120V 60Hz / 220~240V 50Hz

| 型号 Model | 功率 Power | 流量 Q.max | 扬程 H.max | 出水口 Outlet | 产品尺寸 Product size | 纸箱尺寸 Carton size | 件/箱 pcs/ctn | 重量 Weight |
|-------------|-------------|-------------|-------------|---------------|----------------------|---------------------|----------------|--------------|
| HAX-15 | 60w | 20000L/h | 2m | 75mm | Φ18x62cm | 54×27.5×67cm | 2/1 | 10kg |
| HAX-20 | 85w | 25000L/h | 2.6m | 75mm | Φ18x62cm | 54×27.5×67cm | 2/1 | 10.09kg |
| HAX-25 | 105w | 30000L/h | 3m | 75mm | Φ18x62cm | 54×27.5×67cm | 2/1 | 10.12kg |
| HAX-30 | 150w | 35000L/h | 3.8m | 90mm | Φ19.5x65cm | 54×27.5×67cm | 2/1 | 12.09kg |
| HAX-35 | 200w | 40000L/h | 5m | 90mm | Φ19.5x65cm | 54×27.5×67cm | 2/1 | 12.39kg |
| HAX-50 | 250w | 50000L/h | 5.5m | 110mm | Φ24x72cm | 29.5×29.5×74cm | 1/1 | 8.65kg |

| 消耗类配件 Consumption parts | |
|-------------------------|------------|
| 型号 Model | 编码 Code |
| 转子 Impeller | |
| HAX-15 | YB80018 |
| HAX-20 | YB80018 |
| HAX-25 | YB80018 |
| HAX-30 | YB80017 |
| HAX-35 | YB80017 |
| HAX-50 | YB80038 |



HA/HAS锦鲤池泵 HA/HAS KAM CARP POND PUMP

- 采用高性能电容电机，陶瓷轴转子，稳顺低噪。
- 散热性能好，设有过热保护。
- 低水位吸水，流量大。
- Adopt high performance capacitor motor and ceramic impeller, stable, low noise.
- Good heat dissipation performance, with overheating protection.
- Water absorption at low water level and large flow.



HAS

HA

110~120V 60Hz / 220~240V 50Hz

| 型号 Model | 功率 Power | 流量 Q.max | 扬程 H.max | 出水口 Outlet | 产品尺寸 Product size | 纸箱尺寸 Carton size | 件/箱 pcs/ctn | 重量 Weight |
|-------------|-------------|-------------|-------------|---------------|----------------------|---------------------|----------------|--------------|
| HA-20 | 175w | 15500L/h | 2.6m | 75mm | Φ18x62cm | 55×28×67cm | 2/1 | 11.5kg |
| HA-25 | 190w | 17000L/h | 3.2m | 75mm | Φ18x62cm | 55×28×67cm | 2/1 | 11.5kg |
| HA-30 | 270w | 26000L/h | 3.8m | 90mm | Φ19.5x65cm | 55×28×67cm | 2/1 | 14.5kg |
| HA-35 | 330w | 28000L/h | 4m | 90mm | Φ19.5x65cm | 55×28×67cm | 2/1 | 14.5kg |
| HAS-20 | 175w | 15500L/h | 2.6m | 75mm | Φ18x32cm | 45.7×42.7×35.5cm | 4/1 | 18.1kg |
| HAS-25 | 190w | 17000L/h | 3.2m | 75mm | Φ18x32cm | 45.7×42.7×35.5cm | 4/1 | 17.9kg |
| HAS-30 | 270w | 26000L/h | 3.8m | 90mm | Φ19.5x35cm | 58.7×43.7×39cm | 4/1 | 24.2kg |
| HAS-35 | 330w | 28000L/h | 4m | 90mm | Φ19.5x35cm | 58.7×43.7×39cm | 4/1 | 24.2kg |

| 消耗类配件 Consumption parts | |
|-------------------------|------------|
| 型号 Model | 编码 Code |
| 转子 Impeller | |
| HA-20, HAS-20 | YB80025 |
| HA-25, HAS-25 | YB80023 |
| HA-30, HAS-30 | YB80021 |
| HA-35, HAS-35 | YB80019 |

NEW TF3合1潜水泵
TF 3 IN 1 WATER PUMP

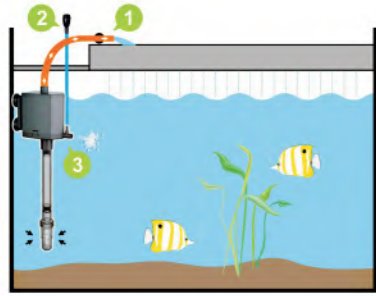

- 适用于鱼缸抽水过滤。
- 1集泵水、2进气、3喷水三项功能于一体。
- 节能电机搭配耐磨转子，高效低噪。
- It is suitable for fish tank pumping and filtering.
- Set 1 water pumping, 2 air intake, 3 water spray three functions in one.
- Energy saving motor with wear-resistant impeller, high efficiency and low noise.



110~120V 60Hz / 220~240V 50Hz

| 型号 Model | 功率 Power | 流量 Q.max | 扬程 H.max | 产品尺寸 Product size | 纸箱尺寸 Carton size | 件/箱 Pcs/Ctn | 重量 Weight |
|-------------|-------------|-------------|-------------|----------------------|---------------------|----------------|--------------|
| TF-1000 | 6w | 370L/h | 0.9m | 10.3×5×9.7cm | 44×36×29cm | 20/1 | 9.4kg |
| TF-1500 | 13w | 700L/h | 1.3m | 13×5.8×11cm | 44×36×29cm | 20/1 | 14.0kg |
| TF-2000 | 29w | 900L/h | 2m | 14.5×7×12cm | 44×36×29cm | 20/1 | 17.1kg |

| 消耗类配件 Consumption class parts | | |
|-------------------------------|----------------|--------------------|
| 编码 Code | 转子 Impeller | 配件包 Spare parts |
| TF-1000 | WP10070 | WP10082 |
| TF-1500 | WP10071 | WP10081 |
| TF-2000 | WP10072 | |

PH潜水泵
PH WATER PUMP

- 适用鱼缸、水池、园林造景，抽水进气。
- 采用节能电机，搭配耐磨转子，强劲、低噪。
- 水陆两用，淡/海水适用。
- Suitable for fish tanks, water pool, water pumping and increase oxygen.
- Adopt energy-saving motor and wear-resisting impeller stronger and low noise.
- Suitable for freshwater and marine water, amphibious pump.



110~120V 60Hz / 220~240V 50Hz

| 型号 Model | 功率 Power | 流量 Q.max | 扬程 H.max | 纸箱尺寸 Carton size | 件/箱 Pcs/Ctn | 重量 Weight |
|-------------|-------------|-------------|-------------|---------------------|----------------|--------------|
| PH-300s | 5w | 360L/h | 0.8m | 45.8×25.2×45.3cm | 60/1 | 16.2kg |
| PH-400s | 6w | 600L/h | 0.85m | 34.8×33.9×34.9cm | 36/1 | 12.5kg |
| PH-500s | 8w | 730L/h | 0.98m | 34.8×33.9×34.9cm | 36/1 | 15.0kg |
| PH-1100s | 15w | 1100L/h | 1.4m | 38.5×35.6×44.4cm | 24/1 | 19.1kg |
| PH-2000s | 31w | 2200L/h | 2.2m | 43.8×36×54.2cm | 24/1 | 29.3kg |
| PH-2500s | 45w | 2500L/h | 2.25m | 41.8×30.2×44.4cm | 12/1 | 20.6kg |
| PH-3000s | 60w | 2880L/h | 2.6m | 41.7×30.2×44.3cm | 12/1 | 20.8kg |
| PH-3500s | 61w | 3500L/h | 2.9m | 43.5×23.2×30.8cm | 6/1 | 14.9kg |
| PH-4000s | 80w | 4300L/h | 3.4m | 43.5×23×30.7cm | 6/1 | 14.8kg |

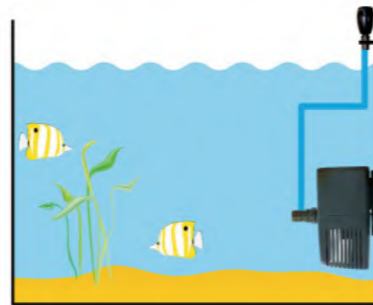

| 消耗类配件 Consumption class parts | | |
|-------------------------------|----------------|--------------------|
| 编码 Code | 转子 Impeller | 配件包 Spare parts |
| PH-300s | WP10083 | WP10084 |
| PH-400s | WP10045 | WP10085 |
| PH-500s | WP10043 | |
| PH-1100s | WP10012 | WP10010 |
| PH-2000s | WP10009 | WP10087 |
| PH-2500s | WP10086 | |
| PH-3000s | WP10007 | |
| PH-3500s | WP10006 | |
| PH-4000s | WP10004 | |

AT-101s潜水泵
AT-101s WATER PUMP

- 适用鱼缸、水池、园林造景，抽水进气。
- 采用节能电机，搭配耐磨转子，强劲、低噪。
- 水中使用，淡/海水适用。
- Suitable for fish tanks, water pool, water pumping and increase oxygen.
- Adopt energy-saving motor and wear-resisting impeller stronger and low noise.
- Used in freshwater and marine water.



110~120V 60Hz / 220~240V 50Hz

| 型号 Model | 功率 Power | 流量 Q.max | 扬程 H.max | 可调 Adjustable | 纸箱尺寸 Carton size | 件/箱 Pcs/Ctn | 重量 Weight |
|-------------|-------------|-------------|-------------|------------------|---------------------|----------------|--------------|
| AT-101s | 4w | 350L/h | 0.6m | ✓ | 40.3×34.8×42.3cm | 60/1 | 18.2kg |
| AT-102s | 6w | 500L/h | 1.05m | ✓ | 43.5×28×46.7cm | 48/1 | 19.8kg |
| AT-103s | 11w | 1300L/h | 1.2m | ✓ | 32.1×31×37.9cm | 24/1 | 16.3kg |
| AT-104s | 28w | 2000L/h | 2m | ✓ | 36.5×33×43.9cm | 24/1 | 21.8kg |
| AT-105s | 37w | 3000L/h | 3m | × | 37.3×34.5×32.6cm | 12/1 | 16.6kg |
| AT-106s | 72w | 4000L/h | 4m | × | 45.1×36.5×33.8cm | 12/1 | 25.7kg |
| AT-107s | 85w | 5000L/h | 5m | × | 38×24.3×35.6cm | 6/1 | 16.8kg |



| 消耗类配件 Consumption parts | | |
|-------------------------|----------------|--------------------|
| 编码 Code | 转子 Impeller | 配件包 Spare parts |
| AT-101s | WP10066 | WP10065 |
| AT-102s | WP10064 | |
| AT-103s | WP10062 | |
| AT-104s | WP10060 | |
| AT-105s | WP10058 | |
| AT-106s | WP10056 | |
| AT-107s | WP10054 | |

AT-200潜水泵
AT-200 WATER PUMP

- 适用鱼缸、水池，抽水进气。
- 采用节能电机，搭配耐磨转子，强劲、低噪。
- 水中使用，淡/海水适用。
- Suitable for fish tanks, water pool, water pumping and increase oxygen.
- Adopt energy-saving motor and wear-resisting impeller, stronger and low noise.
- Used in freshwater and marine water.



110~120V 60Hz / 220~240V 50Hz

| 型号 Model | 功率 Power | 流量 Q.max | 扬程 H.max | 可调 Adjustable | 纸箱尺寸 Carton size | 件/箱 Pcs/Ctn | 重量 Weight |
|-------------|-------------|-------------|-------------|------------------|---------------------|----------------|--------------|
| AT-201 | 9w | 650L/h | 0.9m | × | 38.9×34.2×50.3cm | 48/1 | 21.1kg |
| AT-202 | 12w | 1200L/h | 1.3m | ✓ | 37.4×30.3×42.3cm | 24/1 | 14.8kg |
| AT-203 | 32w | 2000L/h | 2m | ✓ | 39.2×33.9×45.5cm | 24/1 | 23.8kg |



| 消耗类配件 Consumption parts | | |
|-------------------------|----------------|--------------------|
| 编码 Code | 转子 Impeller | 配件包 Spare parts |
| AT-201 | WP10051 | WP10052 |
| AT-202 | WP10049 | WP10050 |
| AT-203 | WP10047 | WP10048 |

AT-300s潜水泵 AT-300s WATER PUMP

- 适用鱼缸、水池，抽水进气。
- 采用节能电机，搭配耐磨转子，强劲、低噪。
- 水中使用，淡/海水适用。
- Suitable for fish tanks, water pool, water pumping and increase oxygen.
- Adopt energy-saving motor and wear-resisting impeller, stronger and low noise.
- Used in fresh water and marine water.



110~120V 60Hz / 220~240V 50Hz

| 型号 Model | 功率 Power | 流量 Q.max | 扬程 H.max | 可调 Adjustable | 纸箱尺寸 Carton size | 件/箱 Pcs/Ctn | 重量 Weight |
|-------------|-------------|-------------|-------------|------------------|---------------------|----------------|--------------|
| AT-300s | 2w | 150L/h | 0.4m | ✓ | 31.5×23.8×43cm | 60/1 | 8.4kg |
| AT-301s | 2.5w | 230L/h | 0.5m | ✓ | 40.3×34.8×42.3cm | 60/1 | 11.6kg |
| AT-318s | 6w | 280L/h | 0.5m | ✓ | 43.5×28×46.7cm | 60/1 | 11.9kg |
| AT-302s | 5w | 450L/h | 0.7m | ✓ | 32.1×31×37.9cm | 60/1 | 17.7kg |
| AT-303s | 6w | 600L/h | 0.9m | × | 36.5×33×43.9cm | 48/1 | 17.3kg |
| AT-304s | 8w | 800L/h | 1.1m | × | 37.3×34.5×32.6cm | 48/1 | 20.2kg |
| AT-305s | 13w | 1200L/h | 1.3m | × | 45.1×36.5×33.8cm | 24/1 | 16.5kg |
| AT-306s | 27w | 2000L/h | 2m | × | 38×24.3×35.6cm | 24/1 | 25.6kg |



| 消耗类配件 Consumption parts | | |
|-------------------------|----------------|--------------------|
| 编码 Code | 转子 Impeller | 配件包 Spare parts |
| 型号 Model | | |
| AT-300s | WP10089 | WP10090 |
| AT-301s | WP10092 | |
| AT-302s | WP10019 | WP10046 |
| AT-303s | WP10045 | |
| AT-304s | WP10043 | WP10044 |
| AT-305s | WP10041 | WP10042 |
| AT-306s | WP10039 | WP10040 |

AT-400潜水泵 AT-400 WATER PUMP

- 适用鱼缸、水池，抽水进气。
- 采用节能电机，搭配耐磨转子，强劲、低噪。
- 水陆两用，淡/海水适用。
- Suitable for fish tanks, water pool, water pumping and increase oxygen.
- Adopt energy-saving motor and wear-resisting impeller, stronger and low noise.
- Amphibious pump, used in freshwater or marine water.



110~120V 60Hz / 220~240V 50Hz

| 型号 Model | 功率 Power | 流量 Q.max | 扬程 H.max | 可调 Adjustable | 纸箱尺寸 Carton size | 件/箱 Pcs/Ctn | 重量 Weight |
|-------------|-------------|-------------|-------------|------------------|---------------------|----------------|--------------|
| AT-401 | 7w | 380L/h | 0.95m | ✓ | 35.5×34×28.7cm | 24/1 | |
| AT-402 | 7.5w | 400L/h | 1.05m | ✓ | 28×24.5×31.8cm | 24/1 | 10.1kg |
| AT-403 | 13.5w | 750L/h | 1.6m | ✓ | 29.5×28×36.3cm | 24/1 | 24.8kg |



AT-600节能水泵 AT-600 WATER PUMP

- 适用鱼缸、水池、园林造景。
- 采用节能电机，搭配耐磨转子，强劲、低噪。
- 水陆两用，淡/海水适用。
- Suitable for fish tanks, water pool.
- Adopt energy-saving motor and wear-resisting impeller, stronger and low noise.
- Amphibious pump, used in freshwater and marine water.

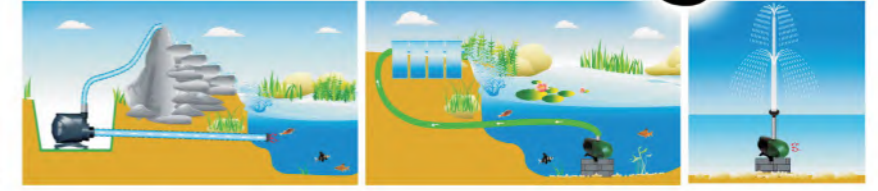

110~120V 60Hz / 220~240V 50Hz

| 型号 Model | 功率 Power | 流量 Q.max | 扬程 H.max | 纸箱尺寸 Carton size | 件/箱 Pcs/Ctn | 重量 Weight |
|-------------|-------------|-------------|-------------|---------------------|----------------|--------------|
| AT-603 | 22w | 1500L/h | 2.1m | 40.8×35×37cm | 18/1 | 17.4kg |
| AT-604 | 27.5w | 2100L/h | 2.2m | 45.8×26.8×41.5cm | 12/1 | 15.7kg |
| AT-605 | 47w | 2500L/h | 2.8m | 45.8×26.8×41.5cm | 12/1 | 16.1kg |
| AT-606 | 69w | 3100L/h | 3.2m | 41×24.5×43cm | 9/1 | 15.2kg |
| AT-607 | 83w | 3600L/h | 3.6m | 41×24.5×43cm | 9/1 | 15.6kg |
| AT-608 | 100w | 4800L/h | 3.7m | 44×27×32cm | 6/1 | 13.9kg |

| 消耗类配件 Consumption parts | | |
|-------------------------|----------------|--------------------|
| 编码 Code | 转子 Impeller | 配件包 Spare parts |
| 型号 Model | | |
| AT-603 | WP10013 | WP10077 |
| AT-604 | WP10007 | |
| AT-605 | WP10058 | WP10078 |
| AT-606 | WP10074 | |
| AT-607 | WP10075 | WP10079 |
| AT-608 | WP10076 | WP10080 |

NEW USB水泵 USB WATER PUMP

- 采用USB电源，适用于小型鱼缸。
- 微型电机节能静音，淡/海水适用。

- USB power supply, suitable for small fish tank.
- Micro motor energy-saving mute, applicable to fresh/marine water.

Input: AC 110~240V 50/60Hz Output: DC 5v, DC 12v

| 型号 Model | 功率 Power | 流量 Q.max | 扬程 H.max | 产品尺寸 Product size |
|----------------|-------------|-------------|-------------|----------------------|
| AT-300U(DC5V) | 1.7w | 250L/h | 1.1m | 3.2×3.9×4.2cm |
| AT-300U(DC12V) | 3.8w | 350L/h | 2.3m | 3.2×3.9×4.2cm |



AT盘景水泵 AT MINIASCPE PUMP



| 型号 Model | 灯功率 Light Power | 泵功率 Pump Power | 流量 Q.max | 扬程 H.max |
|-------------|--------------------|-------------------|-------------|-------------|
| AT-300L/LED | 5w | 6w | 180L/h | 0.45m |
| AT-301L/LED | 5w | 7.5w | 230L/h | 0.65m |
| AT-318L/LED | 5w | 9w | 350L/h | 0.5m |
| AT-302L/LED | 5w | 10.5w | 450L/h | 0.75m |

| 型号 Model | 灯功率 Light Power | 泵功率 Pump Power | 流量 Q.max | 扬程 H.max |
|-------------|--------------------|-------------------|-------------|-------------|
| AT-401L/LED | 5w | 10w | 380L/h | 0.95m |
| AT-402L/LED | 5w | 12w | 400L/h | 1.05m |
| AT-403L/LED | 5w | 18.5w | 800L/h | 1.6m |

NEW BP双倍静气泵
BP QUIET AIR PUMP



- 适用于鱼缸、鱼池打气。
- 双层外壳，低噪静音。
- 气量强劲，大小可调。
- 造气水深达2.5米。
- Suitable for fish tank and fish pond.
- Double shell ultra quiet design.
- Adjustable powerful air flow.
- Pumps air down to 2.5m.



110~120V 60Hz / 220~240V 50Hz

| 型号 Model | 功率 Power | 气流量 Flow Rate | 气压 Pressure | 气嘴 Outlet | 可调 Adjustable | 噪音 Noise | 纸箱尺寸 Carton size | 件/箱 pcs/ctn | 重量 Weight |
|-------------|-------------|------------------|----------------|--------------|------------------|-------------|---------------------|----------------|--------------|
| BP-400 | 4w | 2.6L/min | 0.018Mpa | 2 | ✓ | <36dB | 44×39.5×34cm | 24/1 | 19.7kg |
| BP-500 | 5w | 4.0L/min | 0.020Mpa | 2 | ✓ | <38dB | 46×39.5×26cm | 18/1 | 17.9kg |
| BP-600 | 6w | 4.6L/min | 0.025Mpa | 2 | ✓ | <40dB | 44×24×38cm | 12/1 | 14.0kg |
| BP-800 | 10w | 3.5L/min | 0.022Mpa | 4 | ✓ | <39dB | 39×24.5×42cm | 8/1 | 13.9kg |



NEW AD交/直流充电气泵
AD AC/DC CHARGING AIR PUMP



- 交/直流电通用，优质锂电充电。
- 四档气量调节，可选连续或间断模式。
- 满电连续工作40小时，间断工作70小时。
- Used for AC/DC, high quality lithium battery charging.
- With four levels of air flow, continuous mode or intermittent mode are optional.
- Fully charged can work continuously for 40 hours and intermittently for 70 hours.



110~120V 60Hz / 220~240V 50Hz

| 型号 Model | 功率 Power | 气流量 Flow Rate | 气压 Pressure | 气嘴 Outlet | 可调 Adjustable | 噪音 Noise | 纸箱尺寸 Carton size | 件/箱 pcs/ctn | 重量 Weight |
|-------------|----------------|------------------|----------------|--------------|------------------|-------------|---------------------|----------------|--------------|
| AD-100 | AC 3w DC 2w | 4.0L/min | 0.024Mpa | 2 | ✓ | <36dB | 47×26×31cm | 12/1 | 14.4kg |

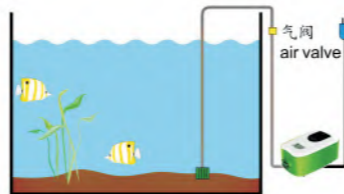

NEW XP气泵
XP AIR PUMP



- 适用于鱼缸、鱼池打气。
- 采用优质气拍，气量强劲，可调节。
- 密封设计，隔音低噪。
- Suitable for fish tank and fish pond.
- Adopt high quality air racket, adjustable powerful air flow.
- Seal and ultra quiet design.

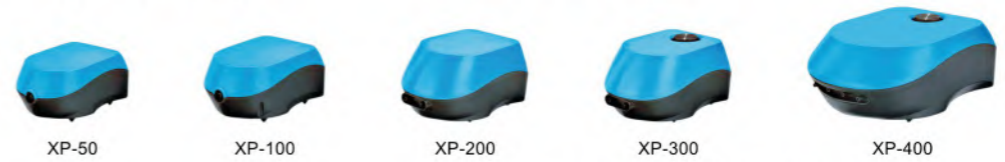

110~120V 60Hz / 220~240V 50Hz

| 型号 Model | 功率 Power | 气流量 Flow Rate | 气压 Pressure | 气嘴 Outlet | 可调 Adjustable | 纸箱尺寸 Carton size | 件/箱 pcs/ctn | 重量 Weight |
|-------------|-------------|------------------|----------------|--------------|------------------|---------------------|----------------|--------------|
| XP-50 | 1.8w | 1.5L/min | 0.012Mpa | 1 | × | 38×28×30cm | 48/1 | 10.5kg |
| XP-100 | 2.0w | 3.0L/min | 0.020Mpa | 1 | × | 42×32×38cm | 40/1 | 12.0kg |
| XP-200 | 3.5w | 2.6L/min | 0.020Mpa | 2 | × | 42×39×33.5cm | 24/1 | 14.7kg |
| XP-300 | 4.5w | 3.5L/min | 0.022Mpa | 2 | ✓ | 42×39×33.5cm | 24/1 | 18.3kg |
| XP-400 | 9.0w | 3.5L/min | 0.022Mpa | 4 | ✓ | 46×32×35cm | 12/1 | 16.3kg |

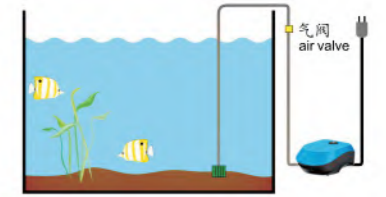

NEW KP气泵
KP AIR PUMP



- 适用于水族鱼缸、鱼池等增氧之用。
- 采用优质气拍，气量强劲，可调节。
- 密封设计，隔音低噪。
- Suitable for fish tank and fish pond.
- Adopt high quality air racket, adjustable powerful air flow.
- Seal and ultra quiet design.



110~120V 60Hz / 220~240V 50Hz

| 型号 Model | 功率 Power | 气流量 Flow Rate | 气压 Pressure | 气嘴 Outlet | 可调 Adjustable | 纸箱尺寸 Carton size | 件/箱 pcs/ctn | 重量 Weight |
|-------------|-------------|------------------|----------------|--------------|------------------|---------------------|----------------|--------------|
| KP-200 | 2.0w | 2.0L/min | 0.014Mpa | 1 | × | 40×29×32cm | 40/1 | 13.0kg |
| KP-400 | 3.8w | 4.0L/min | 0.016Mpa | 2 | ✓ | 44×37×35cm | 24/1 | 19.2kg |
| KP-500 | 4.5w | 5.0L/min | 0.022Mpa | 2 | ✓ | 44×37×35cm | 24/1 | 19.2kg |
| KP-600 | 5.0w | 5.8L/min | 0.030Mpa | 2 | ✓ | 44×37×35cm | 24/1 | 19.2kg |

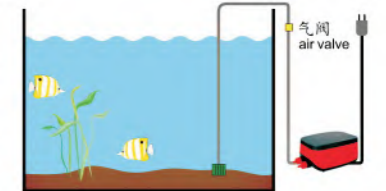

NEW DP气泵(气立方)
DP AIR PUMP (ATR CUBE)



- 适用于大鱼缸、池塘、水族店打气。
- 防水结构，室内/外通用。
- 双层外壳隔音，静音。
- 气量强劲，深水造气。
- Suitable for fish tank, fish pond and aquarium shop.
- Waterproof, suitable for indoor and outdoor.
- Double shell ultra quiet design.
- Powerful air flow, pumps air to deep water.

110~120V 60Hz / 220~240V 50Hz

| 型号 Model | 功率 Power | 气流量 Flow Rate | 气压 Pressure | 气嘴 Outlet | 可调 Adjustable | 纸箱尺寸 Carton size | 件/箱 pcs/ctn | 重量 Weight |
|-------------|-------------|------------------|----------------|--------------|------------------|---------------------|----------------|--------------|
| DP-10 | 8w | 7.5L/min | 0.018Mpa | 4 | × | 30.5×26.6×33.4cm | 4/1 | 20.6kg |
| DP-20 | 15w | 25L/min | 0.020Mpa | 6 | × | 38.5×32×21.7cm | 2/1 | 26.5kg |
| DP-30 | 20w | 35L/min | 0.028Mpa | 10 | × | 40.3×33×22.3cm | 2/1 | 20.9kg |
| DP-40 | 30w | 55L/min | 0.030Mpa | 20 | × | 40.3×33×22.3cm | 2/1 | 19.5kg |

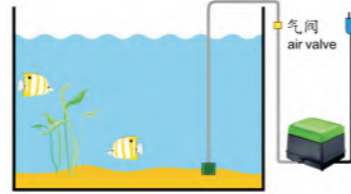

CR气泵
CR AIR PUMP



- 适用于鱼缸、鱼池打气。
- 采用优质气拍，气量强劲，可调节。
- 密封设计，隔音低噪。
- Suitable for fish tank and fish pond.
- Adopt high quality air racket, adjustable powerful air flow.
- Seal and ultra quiet design.



110~120V 60Hz / 220~240V 50Hz

| 型号 Model | 功率 Power | 气流量 Flow Rate | 气压 Pressure | 气嘴 Outlet | 可调 Adjustable | 纸箱尺寸 Carton size | 件/箱 pcs/ctn | 重量 Weight |
|-------------|-------------|------------------|----------------|--------------|------------------|---------------------|----------------|--------------|
| CR-10 | 2.0w | 1.2L/min | 0.020Mpa | 1 | × | 42.1×23.8×42.6cm | 60/1 | 15kg |
| CR-20 | 3.5w | 1.5L/min | 0.020Mpa | 1 | × | 38.5×31.3×47.3cm | 60/1 | 20.4kg |
| CR-20R | 3.5w | 1.5L/min | 0.020Mpa | 1 | ✓ | 33.5×19.3×38.3cm | 24/1 | 8.8kg |
| CR-30 | 3.5w | 1.5L/min | 0.020Mpa | 2 | × | 31.3×19.5×38.2cm | 24/1 | 8.8kg |
| CR-30R | 3.5w | 1.5L/min | 0.020Mpa | 2 | ✓ | 33.4×19.3×38.3cm | 24/1 | 9.4kg |
| CR-40 | 4.0w | 2.0L/min | 0.022Mpa | 2 | × | 35.5×22×40cm | 24/1 | 11.4kg |
| CR-40R | 4.0w | 2.0L/min | 0.022Mpa | 2 | ✓ | 35.4×21.6×40cm | 24/1 | 12.1kg |

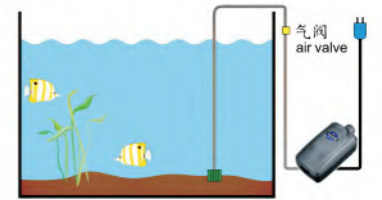

HP气泵
HP AIR PUMP



- 适用于大鱼缸、池塘、水族店打气。
- 防水结构，室内/外通用。
- 加厚外壳隔音，低噪。
- 气量强劲，深水造气。
- It is suitable for big fish tank, pond and aquarium shop.
- Waterproof, suitable for indoor and outdoor.
- With thick shell, sound insulation, low noise.
- Powerful air flow, pumps air to deep water.

110~120V 60Hz / 220~240V 50Hz

| 型号 Model | 功率 Power | 气流量 Flow Rate | 气压 Pressure | 气嘴 Outlet | 可调 Adjustable | 纸箱尺寸 Carton size | 件/箱 pcs/ctn | 重量 Weight |
|-------------|-------------|------------------|----------------|--------------|------------------|---------------------|----------------|--------------|
| HP-4000 | 16w | 30L/min | 0.022Mpa | 4 | × | 30.5×26.6×33.4cm | 4/1 | 11.5kg |
| HP-8000 | 42w | 75L/min | 0.032Mpa | 6 | × | 38.5×32×21.7cm | 2/1 | 10.1kg |
| HP-12000 | 53w | 100L/min | 0.036Mpa | 10 | × | 40.3×33×22.3cm | 2/1 | 14.1kg |
| HP-16000 | 90w | 140L/min | 0.054Mpa | 10 | × | 40.3×33×22.3cm | 2/1 | 14.1kg |

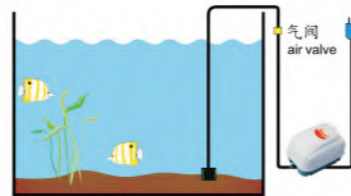

PP气泵
PP AIR PUMP



- 适用于鱼缸、鱼池打气。
- 采用优质气拍，气量强劲。
- 密封设计，隔音低噪。
- Suitable for fish tank and fish pond.
- Adopt high quality air racket, powerful air flow.
- Seal and ultra quiet design.



110~120V 60Hz / 220~240V 50Hz

| 型号 Model | 功率 Power | 气流量 Flow Rate | 气压 Pressure | 气嘴 Outlet | 可调 Adjustable | 纸箱尺寸 Carton size | 件/箱 pcs/ctn | 重量 Weight |
|-------------|-------------|------------------|----------------|--------------|------------------|---------------------|----------------|--------------|
| PP-100 | 2.8w | 1.8L/min | 0.018Mpa | 1 | × | 44×31.6×44cm | 48/1 | 15.4kg |
| PP-200 | 3.5w | 2.5L/min | 0.020Mpa | 1 | × | 47×34×36.5cm | 36/1 | 14.1kg |
| PP-300 | 3.5w | 2.5L/min | 0.020Mpa | 2 | × | 47×34×36.5cm | 36/1 | 14.9kg |
| PP-400 | 4.5w | 3.0L/min | 0.020Mpa | 2 | × | 47×38.8×39.5cm | 30/1 | 17.1kg |

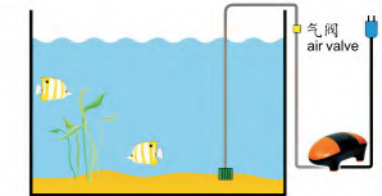

AP气泵 AP AIR PUMP

- 适用于鱼缸、鱼池打气。
- 采用优质气拍，气量强劲，可调节。
- 密封设计，隔音低噪。

- Suitable for fish tank and fish pond.
- Adopt high quality air racket, adjustable powerful air flow.
- Seal and ultra quiet design.



110~120V 60Hz / 220~240V 50Hz

| 型号 Model | 功率 Power | 气流量 Flow Rate | 气压 Pressure | 气嘴 Outlet | 可调 Adjustable | 纸箱尺寸 Carton size | 件/箱 pcs/ctn | 重量 Weight |
|-------------|-------------|------------------|----------------|--------------|------------------|---------------------|----------------|--------------|
| AP-12C | 1.5w | 1.0L/min | 0.018Mpa | 1 | × | 47×23.5×41.5cm | 60/1 | 12.6kg |
| AP-15C | 2.5w | 1.5L/min | 0.020Mpa | 1 | × | 37.5×27.5×38.8cm | 48/1 | 14.6kg |
| AP-25C | 3.5w | 2.5L/min | 0.020Mpa | 1 | × | 37.5×27.5×38.8cm | 48/1 | 14.6kg |
| AP-35C | 3.5w | 2.5L/min | 0.020Mpa | 2 | × | 46×29.5×27.8cm | 32/1 | 11.5kg |
| AP-45C | 4.0w | 3.0L/min | 0.020Mpa | 2 | × | 46×31.5×28cm | 32/1 | 15.9kg |
| AP-25R | 3.5w | 2.5L/min | 0.020Mpa | 1 | ✓ | 37.8×27.5×41.8cm | 48/1 | 14.6kg |
| AP-35R | 3.5w | 2.5L/min | 0.020Mpa | 2 | ✓ | 46×29.5×27.8cm | 32/1 | 11.1kg |
| AP-45R | 4.0w | 3.0L/min | 0.020Mpa | 2 | ✓ | 46×31.5×28cm | 32/1 | 15.9kg |

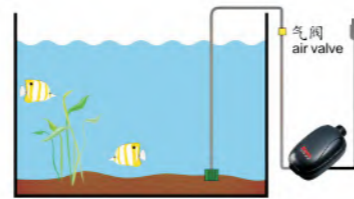

AT-A气泵 AT-A AIR PUMP

- 适用于鱼缸、鱼池打气。
- 采用优质气拍，气量强劲，可调节。
- 密封设计，隔音低噪。

- Suitable for fish tank and fish pond.
- Adopt high quality air racket, adjustable powerful air flow.
- Seal and ultra quiet design.



110~120V 60Hz / 220~240V 50Hz

| 型号 Model | 功率 Power | 气流量 Flow Rate | 气压 Pressure | 气嘴 Outlet | 可调 Adjustable | 纸箱尺寸 Carton size | 件/箱 pcs/ctn | 重量 Weight |
|-------------|-------------|------------------|----------------|--------------|------------------|---------------------|----------------|--------------|
| AT-A1500 | 2.5w | 2.0L/min | 0.020Mpa | 1 | × | 37.7×31.6×33.7cm | 60/1 | 12.8kg |
| AT-A2500 | 3.0w | 2.0L/min | 0.020Mpa | 1 | × | 37×31.4×41.4cm | 60/1 | 16.4kg |
| AT-A3500 | 3.0w | 2.0L/min | 0.020Mpa | 1 | × | 37×31.4×41.4cm | 60/1 | 16.6kg |
| AT-A6500 | 4.0w | 3.0L/min | 0.020Mpa | 2 | × | 37.2×31.4×32.2cm | 24/1 | 12.2kg |
| AT-A7500 | 4.0w | 3.0L/min | 0.020Mpa | 2 | ✓ | 39.4×31.4×32cm | 24/1 | 12.6kg |
| AT-A8500 | 5.0w | 4.5L/min | 0.022Mpa | 2 | × | 39.4×33×32.3cm | 24/1 | 16.4kg |
| AT-A9500 | 5.0w | 4.5L/min | 0.022Mpa | 2 | ✓ | 41.5×32.6×32.3cm | 24/1 | 16.6kg |

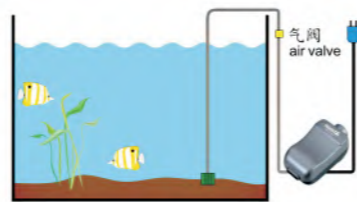

AR气泵 AR AIR PUMP

- 适用于鱼缸、鱼池打气。
- 采用优质气拍，金属气咀，气量强劲，可调。
- 密封设计，隔音低噪。

- Suitable for fish tank and fish pond.
- Adopt high quality air racket, metal outlets, adjustable powerful air flow.
- Seal and ultra quiet design.



110~120V 60Hz / 220~240V 50Hz

| 型号 Model | 功率 Power | 气流量 Flow Rate | 气压 Pressure | 气嘴 Outlet | 可调 Adjustable | 纸箱尺寸 Carton size | 件/箱 pcs/ctn | 重量 Weight |
|-------------|-------------|------------------|----------------|--------------|------------------|---------------------|----------------|--------------|
| AR-2500 | 2.5w | 3.0L/min | 0.020Mpa | 1 | ✓ | 43.5×23.3×39cm | 60/1 | 18.7kg |
| AR-7500 | 3.7w | 3.0L/min | 0.020Mpa | 2 | ✓ | 34.5×21.6×38.8cm | 24/1 | 13.2kg |
| AR-8500 | 5.5w | 4.0L/min | 0.025Mpa | 2 | ✓ | 37.4×22×40.3cm | 24/1 | 18.1kg |

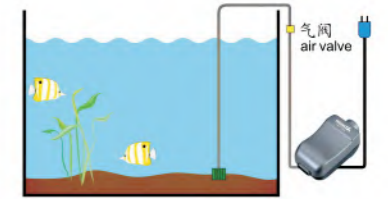

CX气泵 CX AIR PUMP

- 适用于鱼缸、鱼池打气。
- 采用优质气拍，金属气咀，气量强劲，可调。
- 密封设计，隔音低噪。

- Suitable for fish tank and fish pond.
- Adopt high quality air racket, metal outlets, adjustable powerful air flow.
- Seal and ultra quiet design.



110~120V 60Hz / 220~240V 50Hz

| 型号 Model | 功率 Power | 气流量 Flow Rate | 气压 Pressure | 气嘴 Outlet | 可调 Adjustable | 纸箱尺寸 Carton size | 件/箱 pcs/ctn | 重量 Weight |
|-------------|-------------|------------------|----------------|--------------|------------------|---------------------|----------------|--------------|
| CX-0078 | 2.5w | 3.0L/min | 0.020Mpa | 1 | × | 47×31.5×34.5cm | 60/1 | 18.8kg |
| CX-0088 | 3.5w | 3.0L/min | 0.020Mpa | 2 | ✓ | 40×35×36cm | 32/1 | 18.9kg |
| CX-0098 | 5.3w | 4.5L/min | 0.022Mpa | 2 | ✓ | 41.5×33.5×36cm | 24/1 | 18.6kg |

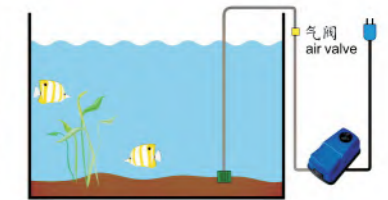

HP气泵 HP AIR PUMP



- 适用于鱼缸、鱼池打气。
- 采用优质气拍，金属气咀，气量强劲，可调。
- 密封设计，隔音低噪。

- Suitable for fish tank and fish pond.
- Adopt high quality air racket, metal outlets, adjustable powerful air flow.
- Seal and ultra quiet design.



110~120V 60Hz / 220~240V 50Hz

| 型号 Model | 功率 Power | 气流量 Flow Rate | 气压 Pressure | 气嘴 Outlet | 可调 Adjustable | 纸箱尺寸 Carton size | 件/箱 pcs/ctn | 重量 Weight |
|-------------|-------------|------------------|----------------|--------------|------------------|---------------------|----------------|--------------|
| HP-1000 | 2.5w | 3.0L/min | 0.020Mpa | 1 | × | 47.5×32.5×36.7cm | 60/1 | 15.1kg |
| HP-2000 | 3.5w | 2.5L/min | 0.020Mpa | 2 | × | 40.8×33.7×37.2cm | 24/1 | 11.7kg |
| HP-5000 | 5w | 2.0L/min | 0.022Mpa | 4 | ✓ | 43.5×38×30.6cm | 18/1 | 13.9kg |
| HP-6000 | 5.5w | 2.0L/min | 0.022Mpa | 6 | ✓ | 48×28.5×33.1cm | 12/1 | 10.5kg |

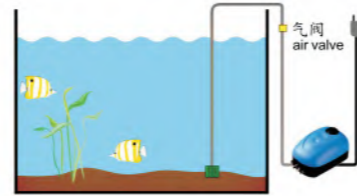

AT&EP气泵 AT&EP AIR PUMP



- 适用于鱼缸、鱼池打气。
- 采用优质气拍，金属气咀，气量强劲，可调。
- 密封设计，隔音低噪。

- Suitable for fish tank and fish pond.
- Adopt high quality air racket, metal outlets, adjustable powerful air flow.
- Seal and ultra quiet design.



110~120V 60Hz / 220~240V 50Hz

| 型号 Model | 功率 Power | 气流量 Flow Rate | 气压 Pressure | 气嘴 Outlet | 可调 Adjustable | 纸箱尺寸 Carton size | 件/箱 pcs/ctn | 重量 Weight |
|----------------|-------------|------------------|----------------|--------------|------------------|---------------------|----------------|--------------|
| AT-701 EP-2500 | 2.5w | 2.5L/min | 0.020Mpa | 1 | ✓ | 42.8×30.3×41.6cm | 60/1 | 20.6kg |
| AT-702 EP-6500 | 3.5w | 3.0L/min | 0.020Mpa | 2 | ✓ | 48.1×27.7×46.8cm | 48/1 | 26.5kg |
| AT-703 EP-8500 | 5.6w | 4.0L/min | 0.020Mpa | 2 | ✓ | 37.5×36×38.3cm | 24/1 | 20.9kg |
| AT-704 EP-9000 | 5.6w | 4.5L/min | 0.020Mpa | 2 | ✓ | 37.4×35.8×38.1cm | 24/1 | 19.5kg |

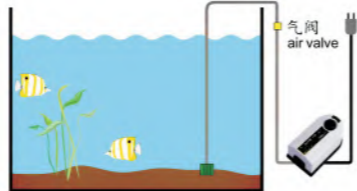

山本气泵 SHANBEN AIR PUMP



- 适用于鱼缸、鱼池打气。
- 采用优质气拍，金属气咀，气量强劲，可调。
- 密封设计，隔音低噪。

- Suitable for fish tank and fish pond.
- Adopt high quality air racket, metal outlets, adjustable powerful air flow.
- Seal and ultra quiet design.

110~120V 60Hz / 220~240V 50Hz

| 型号 Model | 功率 Power | 气流量 Flow Rate | 气压 Pressure | 气嘴 Outlet | 可调 Adjustable | 纸箱尺寸 Carton size | 件/箱 pcs/ctn | 重量 Weight |
|-------------|-------------|------------------|----------------|--------------|------------------|---------------------|----------------|--------------|
| 6500 | 3.5w | 3.0L/min | 0.018Mpa | 2 | ✓ | 41.5×36.5×31.5cm | 32/1 | 19.7kg |
| 8000 | 4.5w | 4.0L/min | 0.020Mpa | 2 | ✓ | 36×31×31.5cm | 24/1 | 18.4kg |

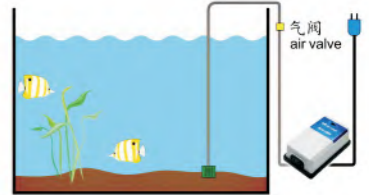

B-1500气泵 B-1500 AIR PUMP

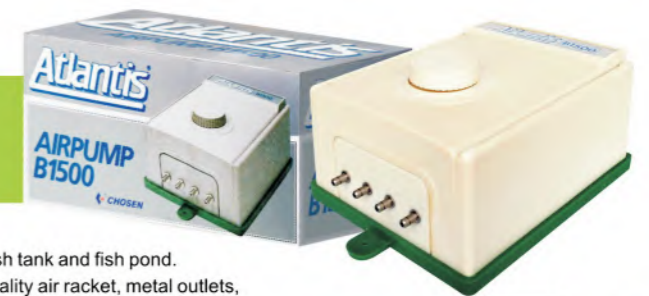

- 适用于鱼缸、鱼池打气。
- 采用优质气拍，金属气咀，气量强劲，可调。
- 密封设计，隔音低噪。

- Suitable for fish tank and fish pond.
- Adopt high quality air racket, metal outlets, adjustable powerful air flow.
- Seal and ultra quiet design.

110~120V 60Hz / 220~240V 50Hz

| 型号 Model | 功率 Power(W) | 气流量 Flow Rate | 气压 Pressure | 气嘴 Outlet | 可调 Adjustable | 纸箱尺寸 Carton size | 件/箱 pcs/ctn | 重量 Weight |
|-------------|----------------|------------------|----------------|--------------|------------------|---------------------|----------------|--------------|
| B-1500 | 9.4w | 4.0L/min | 0.022Mpa | 4 | ✓ | 75×23.5×25cm | 10/1 | 15.1kg |

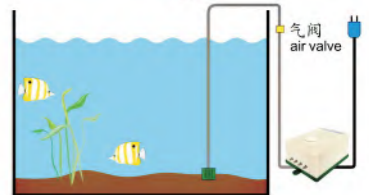

干电池气泵 BATTERY AIR PUMP



- 适用于钓鱼，水产运输时打气。
- 采用优质气拍，单气咀，气量大。
- 用两颗1号大电池供电，低压安全。

- Suitable for pumping during fishing or aquatic transportation.
- Adopt high quality air racket, durable, one outlet, powerful air flow.
- Powered by two D model batteries, low voltage safety.



| 型号 Model | 功率 Power | 气流量 Flow Rate | 气压 Pressure | 气嘴 Outlet | 可调 Adjustable | 纸箱尺寸 Carton size | 件/箱 pcs/ctn | 重量 Weight |
|-------------|-------------|------------------|----------------|--------------|------------------|---------------------|----------------|--------------|
| ATOM-2 | 0.3w | 1.0L/min | 0.012Mpa | 1 | × | 41.2×29.3×32.6cm | 60/1 | 10.8kg |
| DC-128 | 0.3w | 1.0L/min | 0.012Mpa | 1 | × | 46.6×26.7×36cm | 60/1 | 13.8kg |
| DC-250 | 0.3w | 1.0L/min | 0.012Mpa | 1 | × | 44.5×33.2×31.5cm | 60/1 | 11.8kg |

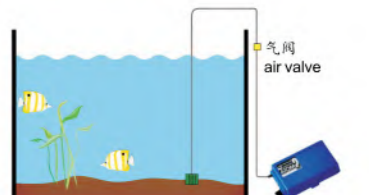

MJ

数控电热膜加热棒 NUMERICAL CONTROL HEATER



- 电子数控，轻松掌控工作情况。
Electronic numerical control, easy to control the working condition.
- 电热膜石英管对水快速循环加热。
The electrothermal membrane quartz tube can heat water rapidly.
- 电热转化率达90%，高效节能。
The electrothermal conversion rate is as high as 90%, high efficiency and energy saving.

6项安全保护，为高端养鱼定制 Safety protections for high end fish farming

- **失控保护** OUT OF CONTROL PROTECTION
双续电器设计，避免续电器失控时导致过度加热。
Double continued electrical apparatus, avoid excessive heating due to uncontrolled relay.
- **离水保护** WATER LEAVING PROTECTION
离水即自动停工，安全可靠。
Automatically shutdown when out of water, safe and reliable.
- **温感保护** THERMOMETRY PROTECTION
采用双探头温感器，测温精准，当温感器失效，加热棒即自动停工。
Dual probe temperature sensor, accurate temperature detection, when the temperature sensor fails, the heating rod shuts down automatically.
- **超温保护** OVER TEMPERATURE PROTECTION
水温超过36℃时，温控器发出超温警报。
When the water temperature exceeds 36℃, the temperature control device sends out an over temperature alarm.
- **过压保护** OVERVOLTAGE PROTECTION
当电压超过280V，即停止工作。
When the supply voltage exceeds 280V, it will stop working.
- **误触保护** WRONG TOUCH PROTECTION
调温旋钮采用防止误触设计，避免错误操作。
The temperature control knob is designed to prevent touching inadvertently, avoid the wrong operation.

| 型号 Model | 功率 Power | 适用鱼缸 Applicable tank | 纸箱尺寸 Carton size | 件/箱 pcs/ctn | 重量 Weight |
|-------------|-------------|-------------------------|---------------------|----------------|--------------|
| MJ-300W | 300W | 300liters | 44×27×48.5cm | 20/1 | 13.96kg |
| MJ-500W | 500W | 500liters | 44×27×48.5cm | 20/1 | 13.96kg |
| MJ-1000W | 1000W | 600liters | 44×27×48.5cm | 20/1 | 16.35kg |



NEW GH石英加热棒 GH QUARTZ HEATER

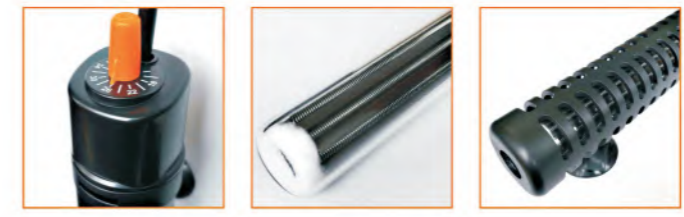

- 管身采用防爆石英管，密封防水。
- 棒身带保护套，使用时更安心。
- 铁铬电热丝，加热准，导热快。
- 顶部旋钮调温，范围20-34℃。
- The tube body is made of explosion-proof quartz tube, sealed and waterproof.
- With protective cover, it is safer to use.
- Ferrochrome heating wire, accurate temperature, thermal conductivity is fast.
- Top temperature adjustment knob, range 20-34℃.

110~120V 60Hz / 220~240V 50Hz

| 型号 Model | 功率 Power | 适用鱼缸 Applicable tank | 纸箱尺寸 Carton size | 件/箱 pcs/ctn | 重量 Weight |
|-------------|-------------|-------------------------|---------------------|----------------|--------------|
| GH-300W | 300W | 300liters | 50×29×37cm | 36/1 | 15.1kg |
| GH-500W | 500W | 500liters | 50×29×40cm | 36/1 | 17.2kg |

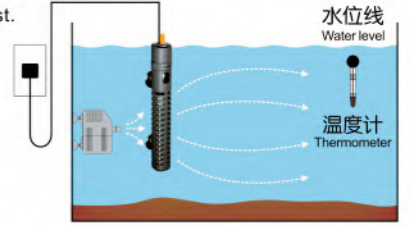

NEW JG玻璃加热棒 JG GLASS HEATER

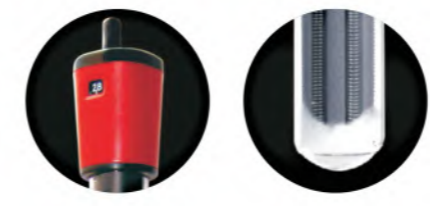

- 管身采用耐高温玻璃，密封防水。
- 铁铬电热丝，加热准，导热快。
- 顶部旋钮调温，范围20-34℃。
- The tube body adopts high temperature resistant glass, sealed and waterproof.
- Ferrochrome heating wire, accurate temperature, thermal conductivity is fast.
- Top temperature adjustment knob, range 20-34℃.

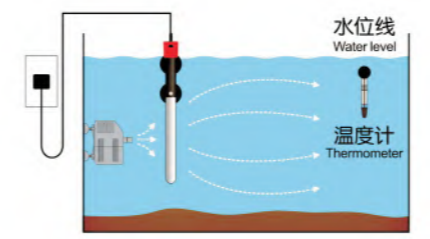

110~120V 60Hz / 220~240V 50Hz

| 型号 Model | 功率 Power | 适用鱼缸 Applicable tank | 纸箱尺寸 Carton size | 件/箱 pcs/ctn | 重量 Weight |
|-------------|-------------|-------------------------|---------------------|----------------|--------------|
| JG-50W | 50W | 50liters | 42.5×34×33cm | 36/1 | 9.63kg |
| JG-100W | 100W | 100liters | 42.5×34×36cm | 36/1 | 10.12kg |
| JG-200W | 200W | 200liters | 42.5×34×40cm | 36/1 | 11.11kg |
| JG-300W | 300W | 300liters | 42.5×34×44cm | 36/1 | 12.12kg |
| JG-500W | 500W | 500liters | 42.5×34×48cm | 36/1 | 13.12kg |



AH石英加热棒 AH QUARTZ HEATER

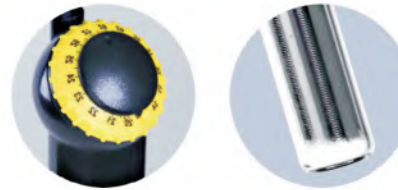

- 管身采用防爆石英管，密封防水。
- 铁铬电热丝，加热准，导热快。
- 顶部环形旋钮调温，范围20-34℃。
- The tube body is made of explosion-proof quartz tube, sealed and waterproof.
- Ferrochrome heating wire, accurate temperature, thermal conductivity is fast.
- Top temperature adjustment knob, range 20-34℃.

110~120V 60Hz / 220~240V 50Hz

| 型号 Model | 功率 Power | 适用鱼缸 Applicable tank | 纸箱尺寸 Carton size | 件/箱 pcs/ctn | 重量 Weight |
|-------------|-------------|-------------------------|---------------------|----------------|--------------|
| AH-50W | 50W | 50liters | 50×29×31cm | 36/1 | 9.45kg |
| AH-100W | 100W | 100liters | 50×29×32cm | 36/1 | 10.97kg |
| AH-200W | 200W | 200liters | 50×29×36cm | 36/1 | 12.46kg |
| AH-300W | 300W | 300liters | 50×29×41cm | 36/1 | 13.94kg |
| AH-500W | 500W | 500liters | 50×29×48cm | 36/1 | 15.46kg |

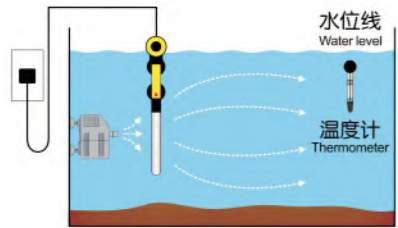

CH玻璃加热棒 CH GLASS HEATER



- 管身采用耐高温玻璃，密封防水。
- 铁铬电热丝，加热准，导热快。
- 顶部旋钮调温，范围20-34℃。
- The tube body adopts high temperature resistant glass, sealed and waterproof.
- Ferrochrome heating wire, accurate temperature, thermal conductivity is fast.
- Top temperature adjustment knob, range 20-34℃.

110~120V 60Hz / 220~240V 50Hz

| 型号 Model | 功率 Power | 适用鱼缸 Applicable tank | 纸箱尺寸 Carton size | 件/箱 pcs/ctn | 重量 Weight |
|-------------|-------------|-------------------------|---------------------|----------------|--------------|
| CH-50W | 50W | 50liters | 50×29×29cm | 36/1 | 9.45kg |
| CH-100W | 100W | 100liters | 50×29×34cm | 36/1 | 10.83kg |
| CH-200W | 200W | 200liters | 50×29×39cm | 36/1 | 11.43kg |
| CH-300W | 300W | 300liters | 50×29×44cm | 36/1 | 12.68kg |

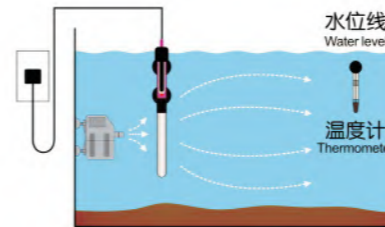

BH石英加热棒 BH QUARTZ HEATER



- 管身采用防爆石英管，密封防水。
- 铁铬电热丝，加热准，导热快。
- 顶部旋钮调温，范围20-34℃。
- The tube body is made of explosion-proof quartz tube, sealed and waterproof.
- Ferrochrome heating wire, accurate temperature, thermal conductivity is fast.
- Top temperature adjustment knob, range 20-34℃.

110~120V 60Hz / 220~240V 50Hz

| 型号 Model | 功率 Power | 适用鱼缸 Applicable tank | 纸箱尺寸 Carton size | 件/箱 pcs/ctn | 重量 Weight |
|-------------|-------------|-------------------------|---------------------|----------------|--------------|
| BH-50W | 50W | 50liters | 50×29×27.5cm | 36/1 | 9.37kg |
| BH-100W | 100W | 100liters | 50×29×29cm | 36/1 | 10.98kg |
| BH-200W | 200W | 200liters | 50×29×33.3cm | 36/1 | 13.87kg |
| BH-300W | 300W | 300liters | 50×29×38.2cm | 36/1 | 14.15kg |

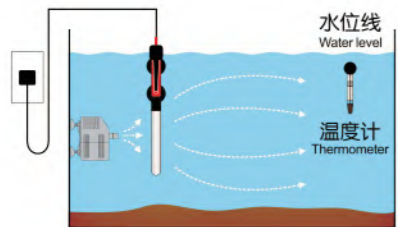

DH玻璃加热棒 DH GLASS HEATER



- 管身采用耐高温玻璃，密封防水。
- 铁铬电热丝，加热准，导热快。
- 顶部旋钮调温，范围20-34℃。
- The tube body adopts high temperature resistant glass, sealed and waterproof.
- Ferrochrome heating wire, accurate temperature, thermal conductivity is fast.
- Top temperature adjustment knob, range 20-34℃.

110~120V 60Hz / 220~240V 50Hz

| 型号 Model | 功率 Power | 适用鱼缸 Applicable tank | 纸箱尺寸 Carton size | 件/箱 pcs/ctn | 重量 Weight |
|-------------|-------------|-------------------------|---------------------|----------------|--------------|
| DH-50W | 50W | 50liters | 50×29×29cm | 36/1 | 9.45kg |
| DH-100W | 100W | 100liters | 50×29×34cm | 36/1 | 10.26kg |
| DH-200W | 200W | 200liters | 50×29×39cm | 36/1 | 10.95kg |
| DH-300W | 300W | 300liters | 50×29×44cm | 36/1 | 11.66kg |

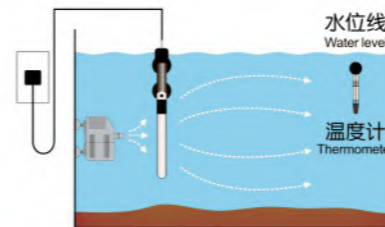

EH玻璃加热棒 EH GLASS HEATER

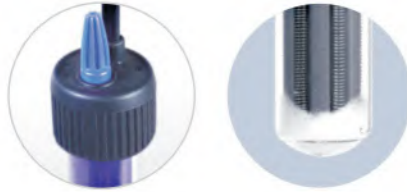

- 管身采用耐高温玻璃，密封防水。
- 铁铬电热丝，加热准，导热快。
- 顶部旋钮调温，范围20-34°C。
- The tube body adopts high temperature resistant glass, sealed and waterproof.
- Ferrochrome heating wire, accurate temperature, thermal conductivity is fast.
- Top temperature adjustment knob, range 20-34°C.

110~120V 60Hz / 220~240V 50Hz

| 型号 Model | 功率 Power | 适用鱼缸 Applicable tank | 纸箱尺寸 Carton size | 件/箱 pcs/ctn | 重量 Weight |
|-------------|-------------|-------------------------|---------------------|----------------|--------------|
| EH-50W | 50W | 50liters | 50×29×33cm | 50/1 | 8.38kg |
| EH-100W | 100W | 100liters | 50×29×33cm | 50/1 | 8.38kg |
| EH-200W | 200W | 200liters | 50×29×37cm | 50/1 | 9.20kg |
| EH-300W | 300W | 300liters | 50×29×41cm | 50/1 | 9.51kg |

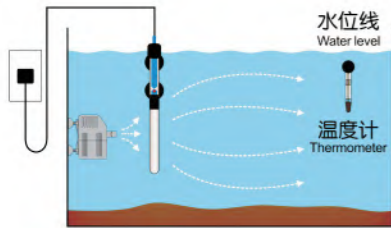

J25玻璃加热棒 J25 GLASS HEATER



- 管身采用耐高温玻璃，密封防水。
- 铁铬电热丝，加热准，导热快。
- 顶部旋钮调温，范围18-34°C。
- The tube body adopts high temperature resistant glass, sealed and waterproof.
- Ferrochrome heating wire, accurate temperature, thermal conductivity is fast.
- Top temperature adjustment knob, range 18-34°C.

110~120V 60Hz / 220~240V 50Hz

| 型号 Model | 功率 Power | 适用鱼缸 Applicable tank | 纸箱尺寸 Carton size | 件/箱 pcs/ctn | 重量 Weight |
|-------------|-------------|-------------------------|---------------------|----------------|--------------|
| J25-25W | 25W | 25liters | 50×29×30cm | 36/1 | 13.87kg |
| J25-50W | 50W | 50liters | 50×29×30cm | 36/1 | 9.37kg |
| J25-100W | 100W | 100liters | 50×29×32cm | 36/1 | 10.98kg |
| J25-200W | 200W | 200liters | 50×29×36cm | 36/1 | 14.15kg |
| J25-300W | 300W | 300liters | 50×29×41cm | 36/1 | 14.15kg |

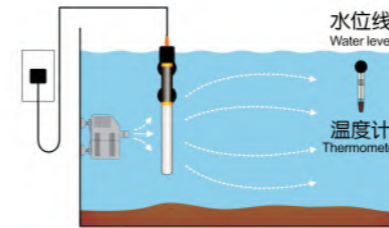

NEW FH玻璃加热棒 FH GLASS HEATER

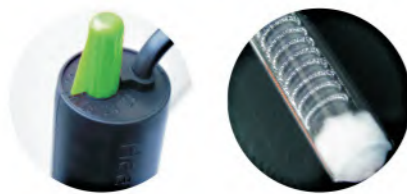

- 管身采用耐高温玻璃，密封防水。
- 铁铬电热丝，加热准，导热快。
- 顶部旋钮调温，范围22-34°C。
- The tube body adopts high temperature resistant glass, sealed and waterproof.
- Ferrochrome heating wire, accurate temperature, thermal conductivity is fast.
- Top temperature adjustment knob, range 22-34°C.

110~120V 60Hz / 220~240V 50Hz

| 型号 Model | 功率 Power | 适用鱼缸 Applicable tank | 纸箱尺寸 Carton size | 件/箱 pcs/ctn | 重量 Weight |
|-------------|-------------|-------------------------|---------------------|----------------|--------------|
| FH-50W | 50W | 50liters | 47×37×25cm | 50/1 | 9.52kg |
| FH-100W | 100W | 100liters | 47×37×29cm | 50/1 | 10.4kg |
| FH-200W | 200W | 200liters | 47×37×35cm | 50/1 | 12.3kg |
| FH-300W | 300W | 300liters | 47×37×38cm | 50/1 | 13.1kg |

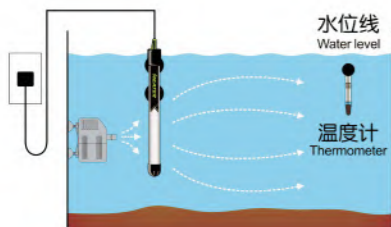

J16恒温加热棒 J16 FIXED TEMPERATURE HEATER



- 管身采用防爆石英管，密封防水。
- 铁铬电热丝，加热准，导热快。
- 定温加热26°C。
- The tube body is made of explosion-proof quartz tube, sealed and waterproof.
- Ferrochrome heating wire, accurate temperature, thermal conductivity is fast.
- Constant temperature heating 26°C.

110~120V 60Hz / 220~240V 50Hz

| 型号 Model | 功率 Power | 适用鱼缸 Applicable tank | 纸箱尺寸 Carton size | 件/箱 pcs/ctn | 重量 Weight |
|-------------|-------------|-------------------------|---------------------|----------------|--------------|
| J16-10W | 10W | 10liters | 34×26×23cm | 36/1 | 6.23kg |
| J16-25W | 25W | 25liters | 34×26×23cm | 36/1 | 6.23kg |
| J16-50W | 50W | 50liters | 50×29×27cm | 36/1 | 6.75kg |
| J16-100W | 100W | 100liters | 50×29×27cm | 36/1 | 7.98kg |

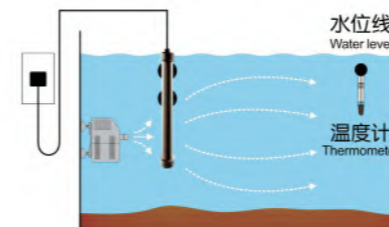

NEW

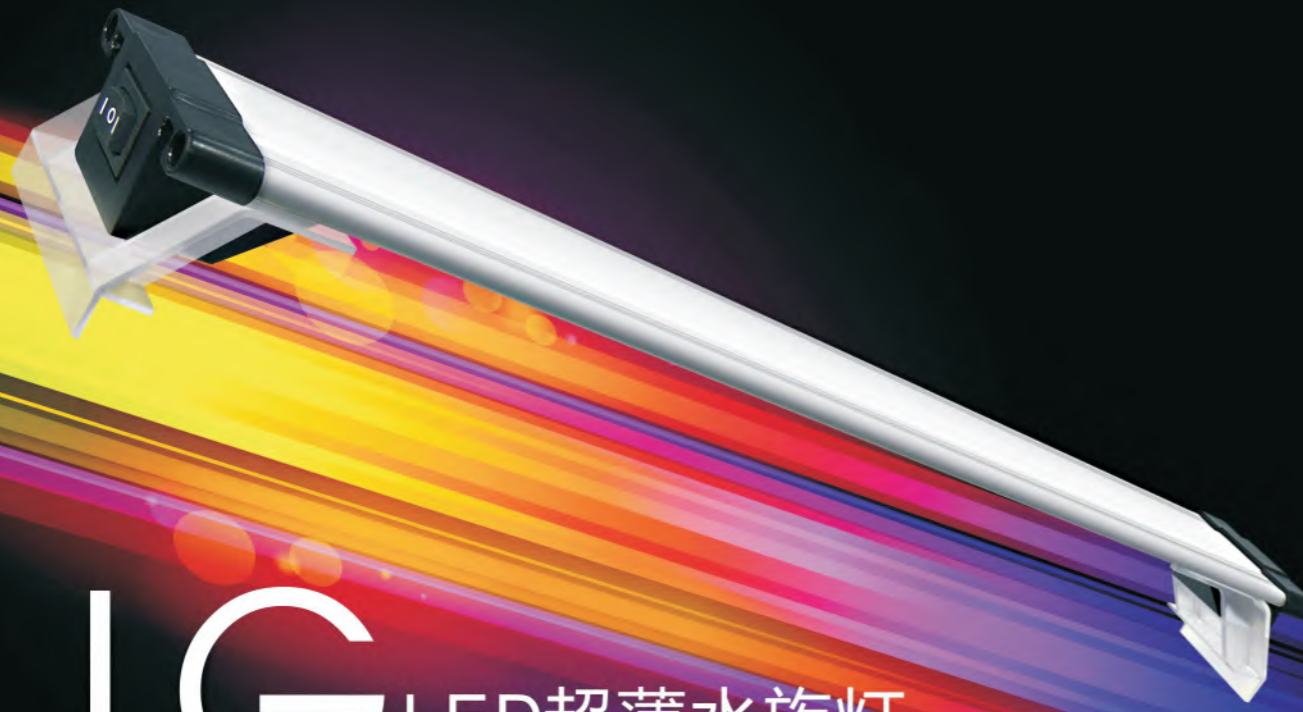

LG LED超薄水族灯

ULTRA THIN AQUARIUM LAMP



10mm厚铝合金灯体，散热性好。
10 mm thick aluminum alloy lamp body, good heat dissipation.



采用高亮度LED灯珠，蓝/白/全亮三种灯光。
With high brightness LED lamp, Blue/White/full light three lighting.



伸缩式支架，安装在鱼缸顶部，通用性强。
Retractable support, put it on the fish tank, universality.

110~120V 60Hz / 220~240V 50Hz

| 型号 Model | 功率 Power | 适用鱼缸 Suit For Aquarium tank | 灯尺寸 Light Size(cm) | 纸箱尺寸 Carton size | 件/箱 pcs/ctn | 重量 Weight |
|-------------|-------------|--------------------------------|-----------------------|---------------------|----------------|--------------|
| LG-450 | 13w | 40-50cm | 45x7cm | 48.5×24.5×28cm | 12/1 | 7.0kg |
| LG-600 | 18w | 55-65cm | 60x7cm | 63.5×24.5×28cm | 12/1 | 8.9kg |
| LG-800 | 20w | 75-85cm | 80x7cm | 83.5×24.5×28cm | 12/1 | 8.0kg |
| LG-900 | 21w | 85-95cm | 90x7cm | 93.5×24.5×28cm | 12/1 | 12.2kg |
| LG-1000 | 22w | 95-105cm | 100x7cm | 103.5×24.5×28cm | 12/1 | 13.2kg |
| LG-1200 | 24w | 115-125cm | 120x7cm | 123.5×24.5×28cm | 12/1 | 19.0kg |

| LGM水草专用 LGM FOR WATERWEEDS | | 功率 Power | 适用鱼缸 Suit For Aquarium tank | 灯尺寸 Light Size(cm) | 纸箱尺寸 Carton size | 件/箱 pcs/ctn | 重量 Weight |
|----------------------------|-----|-------------|--------------------------------|-----------------------|---------------------|----------------|--------------|
| LGM-600 | 20w | 55-65cm | 60x9.4cm | 48.5×24.5×28cm | 12/1 | 8.9kg | |
| LGM-900 | 24w | 85-95cm | 90x9.4cm | 63.5×24.5×28cm | 12/1 | 12.2kg | |
| LGM-1200 | 28w | 115-125cm | 120x9.4cm | 83.5×24.5×28cm | 12/1 | 19.0kg | |



产品颜色
Product color
白 white 黑 black

CX LED智能水族灯

CX LED SMART AQUARIUM LAMP



- 适用于无边框鱼缸。
- 插入式安装在挂钩上。
- 采用高亮度节能LED灯珠。
- 轻触式开关，蓝白灯效互换。
- Suitable for no frame tank.
- The plug is mounted on the hook.
- Using high brightness energy-saving LED lamp beads.
- Touch switch, blue and white two kinds of lamp swap.



110~120V 60Hz / 220~240V 50Hz

| 型号 Model | 功率 Power | 适用鱼缸 Applicable tank | 适用玻璃厚度 Suitable glass | 产品尺寸 Product size | 纸箱尺寸 Carton size | 件/箱 pcs/ctn | 重量 Weight |
|-------------|-------------|-------------------------|--------------------------|----------------------|---------------------|----------------|--------------|
| CX-XSP | 2.8w | 10-20cm | ≤4mm | 14x10.5x6cm | | | |
| CX-SP | 4.5w | 20-35cm | ≤5mm | 17x11.9x8.5cm | 49.5×38×28cm | 20/1 | 7.3kg |
| CX-MP | 8.2w | 35-40cm | ≤6mm | 29x11.9x7cm | 51×31.5×41cm | 18/1 | 8.7kg |
| CX-LP | 8.5w | 40-50cm | ≤6mm | 18.5x11.9x21cm | 46×42×46cm | 16/1 | 9.2kg |

产品颜色
Product color
白 white 黑 black



QL-60 LED智能水族灯

QL-60 LED SMART AQUARIUM LAMP

- 背夹在鱼缸上。
- 设有6H/8H定时开关功能。
- 高亮度节能LED灯珠，光照充足。
- 轻触式开关，白/紫两种灯效选择。
- Back is clamped on the fish tank.
- It has 6H/8H time setting function.
- High brightness LED lamp.
- Touch switch, white / purple lamp effect.

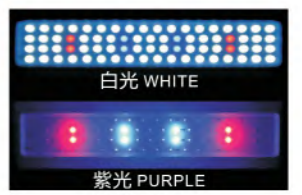
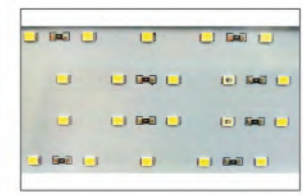

| 型号 Model | 功率 Power | 适用鱼缸 Applicable tank | 适用玻璃厚度 Suitable glass | 产品尺寸 Product size | 纸箱尺寸 Carton size | 件/箱 pcs/ctn | 重量 Weight |
|-------------|-------------|-------------------------|--------------------------|----------------------|---------------------|----------------|--------------|
| QL-60 | 15w | 50-70cm (无边框鱼缸) | ≤6cm | 37.3x20x1.7cm | 53*40*35cm | 18/1 | 8.1kg |

产品颜色
Product color
白 white 黑 black

LA LED超薄水族灯

LA LED ULTRA-THIN AQUARIUM LAMP



- 架置在鱼缸顶部。
- 高亮度LED灯珠。
- 采用超薄铝材，散热好。
- 伸缩支架，通用性强。
- Put it on the fish tank.
- High brightness LED lamp beads.
- Ultra thin aluminum material, good heat dissipation.
- Telescopic support, universal.

110~120V 60Hz / 220~240V 50Hz

| 型号 Model | 功率 Power(W) | 适用鱼缸 Suit For Aquarium tank | 灯尺寸 Light Size(cm) | 纸箱尺寸 Carton size | 件/箱 pcs/ctn | 重量 Weight |
|-------------|----------------|--------------------------------|-----------------------|---------------------|----------------|--------------|
| LA-60 | 13 | 55-70cm | 56.6x8.1 | 71×22×27.3cm | 12/1 | 9.4kg |
| LA-70 | 15 | 65-80cm | 66x8.1 | 81×22×30.8cm | 12/1 | 10.1kg |
| LA-80 | 17 | 75-90cm | 76x8.1 | 91×22×30.8cm | 12/1 | 11.3kg |
| LA-100 | 20 | 95-110cm | 96x8.1 | 121×22×30.8cm | 12/1 | 14.1kg |
| LA-120 | 22 | 110-120cm | 111x8.1 | 128×22×33.8cm | 12/1 | 16.6kg |
| LA-150 | 24 | 145-160cm | 146x8.1 | 171×22×26cm | 12/1 | 21.0kg |

LA LED水族灯

LA LED AQUARIUM LAMP



- LED灯珠，节能高亮。
- 夹在鱼缸上，光照角度可调。

- LED lamp beads, energy saving and bright.
- Clamped on the fish tank, light angle is adjustable.

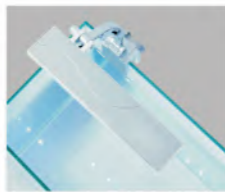

110~120V 60Hz / 220~240V 50Hz

| 型号 Model | 功率 Power(W) | 适用鱼缸 Suit For Aquarium tank | 灯尺寸 Light Size(cm) |
|-------------|----------------|--------------------------------|-----------------------|
| LA-20 | 2.2 | 9 | 20×6.5×1.4 |
| LA-30 | 3 | 12 | 25×6.5×1.4 |
| LA-40 | 4.5 | 24 | 35×6.5×1.4 |

LP 椭圆水族灯

LP AQUARIUM LAMP



- 高亮度灯珠。
- 夹在鱼缸上，光照角度可调。

- High brightness lamp beads.
- Clamped on the fish tank, light angle is adjustable.



80~240V 50/60Hz

| 型号 Model | 功率 Power | 件/箱 pcs/ctn |
|-------------|-------------|----------------|
| LP-50 | 1.0~1.5W | 12 |
| | 2.1~2.4W | 24 |
| | 2.7~3.0W | 36 |

UV水族杀菌灯

AQUARIUM UV LAMP



- 高透光石英管身。
- 254NM高强紫外线。
- 灯水隔离结构，高效杀菌。
- 低电压输出，使用安全。
- High transmittance quartz tube.
- 254nm high-strength ultraviolet.
- Lamp and water isolation structure.
- Low voltage output, safe to use.

110~120V 60Hz / 220~240V 50Hz

| 型号 Model | 防水 Protction | UV强度 ≤5000h | 容量 Capacity | 流量 Flow | 压力 Pressure | 纸箱尺寸 Carton size | 件/箱 pcs/ctn | 重量 Weight |
|-------------|-----------------|----------------|----------------|---------------|----------------|---------------------|----------------|--------------|
| UV-5W | IP44 | ≥85% | 3000L | 1000-1500L/H | 0.2MPa | 45×34×35cm | 6/1 | 11.4kg |
| UV-9W | IP44 | ≥85% | 7000L | 2000-3000L/H | 0.2MPa | 45×37×35cm | 6/1 | 14.3kg |
| UV-11W | IP44 | ≥85% | 10000L | 4000-5000L/H | 0.2MPa | 45×42×35cm | 6/1 | 15.0kg |
| UV-18W | IP44 | ≥85% | 20000L | 6000-8000L/H | 0.2MPa | 45×42×35cm | 6/1 | 17.6kg |
| UV-36W | IP44 | ≥85% | 35000L | 8000-10000L/H | 0.2MPa | 58×45×35cm | 6/1 | 19.5kg |



CASE水族杀菌灯

CASE AQUARIUM UV LAMP



- 高透光石英管身。
- 254NM高强紫外线。
- 灯水隔离结构，高效杀菌。
- 低电压输出，使用安全。
- High transmittance quartz tube.
- 254nm high-strength ultraviolet.
- Lamp and water isolation structure.
- Low voltage output, safe to use.

110~120V 60Hz / 220~240V 50Hz

| 型号 Model | 防水 Protction | UV强度 ≤5000h | 容量 Capacity | 流量 Flow | 压力 Pressure | 纸箱尺寸 Carton size | 件/箱 pcs/ctn | 重量 Weight |
|-------------|-----------------|----------------|----------------|---------------|----------------|---------------------|----------------|--------------|
| CASE UV-5W | IP44 | ≥85% | 3000L | 1000-1500L/H | 0.2MPa | 44.8×39×35cm | 6/1 | 14.1kg |
| CASE UV-9W | IP44 | ≥85% | 7000L | 2000-3000L/H | 0.2MPa | 44.8×39×35cm | 6/1 | 14.1kg |
| CASE UV-11W | IP44 | ≥85% | 10000L | 4000-5000L/H | 0.2MPa | 44.8×41.4×35.2cm | 6/1 | 14.9kg |
| CASE UV-18W | IP44 | ≥85% | 20000L | 6000-8000L/H | 0.2MPa | 50.5×44.8×35cm | 6/1 | 19.2kg |
| CASE UV-36W | IP44 | ≥85% | 35000L | 8000-10000L/H | 0.2MPa | 68.5×44.8×35cm | 6/1 | 22.6kg |

NEW UV水族杀菌灯

AQUARIUM UV LAMP

- 高透光石英管身。
- 254NM高强紫外线。
- 低电压输出，使用安全。
- High transmittance quartz tube.
- 254nm high-strength ultraviolet.
- Low voltage output, safe to use.

110~120V 60Hz / 220~240V 50Hz

| 型号 Model | 防水 Protction |
|-------------|-----------------|
| 7W | IP68 |
| 9W | IP68 |



NEW

MK自吸式除油膜器

MK SELF SUCTION SURFACE SKIMMER

- 自带水泵，可调流量。
- 内有过滤棉，可除油膜和杂质。
- 浮台装有隔栏，防止小鱼吸入。
- With water pump, adjustable flow.
- Built-in sponge, can remove oil and impurities.
- Built-in grille, avoiding small fish into the skimmer.

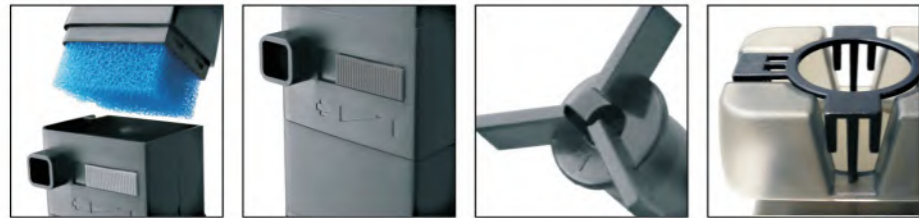

110~120V 60Hz / 220~240V 50Hz

| 型号 Model | 功率 Power | 最大流量 Q Max | 适用鱼缸 Applicable | 产品尺寸 Product size | 纸箱尺寸 Carton size | 个/件 pcs/ctn | 重量 Weight |
|-------------|-------------|---------------|--------------------|----------------------|---------------------|----------------|--------------|
| MK-230 | 2.5W | 300L/h | 20-40cm 10-30L | 5.5x4x16cm | 42x29.5x33cm | 50/1 | 13.1kg |



NEW

SK除油膜器

SK SUFACE SKIMMER

- 去除水面油膜，增加水透光率，有利水草光合作用。
- 自浮式浮台，不因水位高低而影响除油效果。
- 需连接过滤器或水泵。
- Removing water film and increasing water transmittance is beneficial to photosynthesis of aquatic plants.
- With floating platform, suitable for any water level.
- A filter or a water pump should be connected.

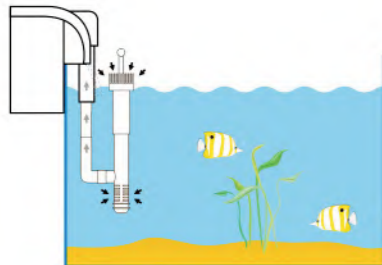

SK-350

SK-600

| 型号 Model | 纸箱尺寸 Carton size | 件/箱 pcs/ctn | 重量 Weight |
|-------------|---------------------|----------------|--------------|
| SK-350 | 45x25x28cm | 20/1 | 2.9kg |
| SK-600 | 47x28.5x38cm | 20/1 | 4.9kg |

NEW

AT二氧化碳扩散器

AT CO₂ DIFFUSER

- 集成了计泡器和止逆阀。
- 采用PE陶瓷高效溶解二氧化碳。
- The bubble counter and check valve are integrated.
- PE ceramic is used to dissolve carbon dioxide efficiently.



| 型号 Model | 3套水咀 3 Sets Outlet | 纸箱尺寸 Carton size | 个/件 pcs/ctn | 重量 Weight |
|-------------|-------------------------------|---------------------|----------------|--------------|
| AT-CO2 | 12/16mm 16/22mm 19/25mm | 45x34x36cm | 36/1 | 8.5kg |

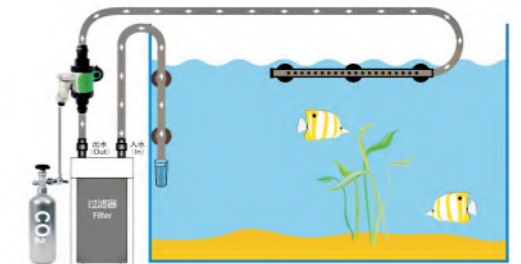

GS鱼缸刮铲

GS FISH TANK BRUSH

- 用于清洁鱼缸玻璃的污渍和青苔。
- 采用304不锈钢刀片，锋利，耐用不生锈。
- 枝杆为高韧性玻璃纤维，韧性十足。
- It is used to clean the stain and moss of aquarium glass.
- Using 304 stainless steel blade, sharp and not easy to be rusted.
- It is made of high tenacity glass fiber with full tenacity.



| 型号 Model | 产品尺寸 Product size |
|-------------|---------------------------------------|
| GS-60 | 6.7x45cm 6.7x65cm (加长/Lengthen) |



NEW AFT-02/03自动喂食器

AFT-02/03 AUTOMATIC FEEDER



- 干电池供电，微型电机，节能静音，待机长。
- 大容量鱼粮盒，适合各类鱼料，投放量可调。
- 设有8H/12H/24H三种定时，还可一键手动喂食。
- 有固定夹和底座，两种安装方式，适合不同鱼缸。
- 背后可接气泵，鱼粮不易受潮。
- Dry battery power supply, micro motor, energy-saving, long standby.
- Large capacity fish feed box, feeding quantity is adjustable, suitable for all kinds of fish feed.
- There are three kinds of timing feeding: 8H / 12H / 24H, one button manual feeding.
- There are fixed clamp and base, two installation methods, suitable for different fish tanks.
- The back of feeder can be connected with air pump, the fish feed is not easy to get damp.

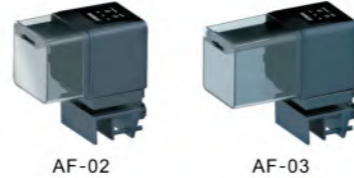

| 型号 Model | 供电 Power supply | 鱼粮盒 Fish food box | 纸箱尺寸 Carton size | 件/箱 pcs/ctn | 重量 Weight |
|-------------|--------------------|----------------------|---------------------|----------------|--------------|
| AFT-02 | 电池 battery (5#×2) | 1 | 48×39.5×42.5cm | 60/1 | 16.8kg |
| AFT-03 | 电池 battery (5#×2) | 1 | 44×47×38cm | 54/1 | 15.1kg |

NEW AFT-04自动喂食器

AFT-04 AUTOMATIC FEEDER



- 交/直流供电，微型电机，节能静音，待机时间长。
- 双层鱼粮盒，容量大，适合各类鱼料，投放量可调。
- 轻触式按键，数显大屏，三段定时，也可一键手动喂食。
- 有固定夹和底座，两种安装方式，适合不同鱼缸。
- 喂食器后背可接气泵，鱼粮不易受潮。
- AC/DC power supply, micro motor, energy-saving, long standby.
- Double layer fish food box, Large capacity, feeding quantity is adjustable, suitable for all kinds of fish feed.
- Touch button, large display, Set the feeding time and quantity accurately three kinds of time setting function a day, one touch manual feeding.
- There are fixed clamp and base, two installation methods, suitable for different fish tanks.
- The back of feeder can be connected with air pump, the fish feed is not easy to get damp.



| 型号 Model | 供电 Power supply | 鱼粮盒 Fish food box | 纸箱尺寸 Carton size | 件/箱 pcs/ctn | 重量 Weight |
|-------------|---|----------------------|---------------------|----------------|--------------|
| AFT-04 | 电池 battery (5#×4) 外接电源 External power supply | 2 | 46×40×46cm | 45/1 | 22.5kg |

AFT自动喂食器

AFT AUTOMATIC FEEDER

- 适合各类鱼料，投放量可调。
- 可设12/24小时定时，一键手动喂食。
- 干电池供电，微型电机，待机长。
- Suitable for all kinds of fish food, adjustable dosage.
- 12/24 hours of regular feeding can be set, one button manual feeding.
- Battery supplies power, Micro motor, long standby.

| 型号 Model | 干电池 Dry battery | 纸箱尺寸 Carton size | 件/箱 pcs/ctn | 重量 Weight |
|-------------|--------------------|---------------------|----------------|--------------|
| AFT-01 | #5×2 | 52×45×46.5cm | 60/1 | 15.16kg |



NEW 水妖精

SPONGE FILTER

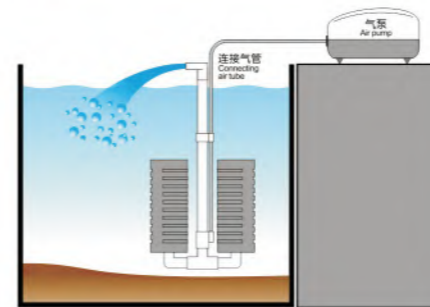

- 材料为高密度棉，用吸盘安装在缸内。
- 需要与气泵连接才能工作。
- 它能起到提升水溶氧量和水体过滤的双重功效。
- The material is high density sponge, installed by suction cup.
- It needs to be connected to the air pump to work.
- It can improve the effect of dissolved oxygen and water filtration.



| 型号 Model | 适用鱼缸 Applicable tank | 纸箱尺寸 Carton size | 件/箱 pcs/ctn | 重量 Weight |
|-------------|-------------------------|---------------------|----------------|--------------|
| S | ≤45cm/50L | 46×41×27cm | 24/1 | 2.4kg |
| M | ≤60cm/90L | 46×41×31cm | 24/1 | 2.9kg |
| L | ≤80cm/140L | 50×41.5×35cm | 30/1 | 3.1kg |

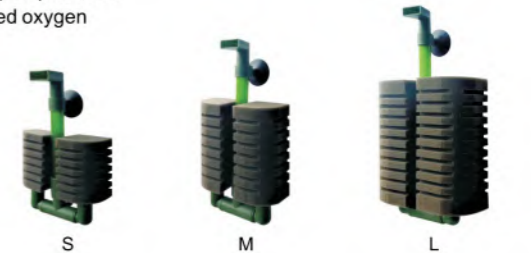

工艺喷泉头

FOUNTAIN HEAD

- 适用于园林喷泉装饰造景。
- 喷泉效果：帐篷、层叠、花洒。
- 配有Φ13、Φ21、Φ27等接驳咀，通用不同鱼缸。

- It is suitable for garden fountain decoration.
- Fountain effect: tents, stacks, showers.
- Equipped with Φ13, Φ21, Φ27 and other connecting nozzles, different fish tanks for general use.



| 型号 Model | 纸箱尺寸 Carton size | 件/箱 pcs/ctn | 重量 Weight |
|-------------|---------------------|----------------|--------------|
| S | 50×42.5×37cm | 80/1 | 8.0kg |
| M | 54.8×40.5×46cm | 24/1 | 9.1kg |
| L | 58×43.3×40.8cm | 12/1 | 5.7kg |

NEW

磁力双头鱼缸刮刷

MAGNETIC DOUBLE SCRAPER FISH TANK BRUSH



- 双头刮铲设计，清洁功效加倍。
- 采用304不锈钢刀片，锋利，耐用不生锈。
- 强磁吸附，松脱自浮。
- 采用软毛刷和魔术贴刷，清洁玻璃不伤表面。
- Double head scraper design, double cleaning effect.
- 304 stainless steel blade, sharp and rust free.
- Strong magnetic adsorption, self floating after loosening.
- Use soft bristle brush and velcro brush to clean the glass without damaging the surface.



GC-12



GC-19

| 型号 Model | 玻璃厚度 Glass Thickness | 尺寸 Size | 纸箱尺寸 Carton size | 件/箱 pcs/ctn | 重量 Weight |
|-------------|-------------------------|--------------|---------------------|----------------|--------------|
| GC-12 | 8-12mm | 14.8×6×8.7cm | 49×37×24.5cm | 20/1 | 7.4kg |
| GC-19 | 12-19mm | 14.8×6×8.7cm | 49×37×24.5cm | 20/1 | 8.8kg |

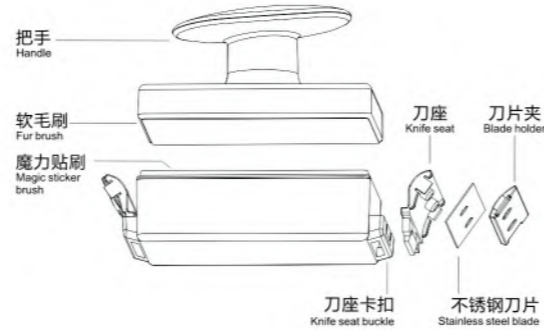

磁力鱼缸刷

MAGNETIC FISH TANK BRUSH

- 采用防滑手柄，自浮式设计。
- 超强磁力，适合不同玻璃厚度使用。
- 采用防刮伤清洁垫，有效清洁玻璃。
- It adopts anti-skid handle, self floating design.
- Super magnetic force, suitable for different glass thickness.
- Use anti scratch cleaning pad to clean the glass effectively.



MF-1

MF-5

MF-10

MF-15

| 型号 Model | 玻璃厚度 Glass Thickness | 尺寸 Size(mm) | 纸箱尺寸 Carton size | 件/箱 pcs/ctn | 重量 Weight |
|-------------|-------------------------|----------------|---------------------|----------------|--------------|
| MF-1 | ≤4mm | 71×25×67 | 42.5×29.5×31.5cm | 120/1 | 13.6kg |
| MF-5 | ≤5mm | 71.5×38×62 | 42.5×29.5×31.5cm | 84/1 | 12.6kg |
| MF-10 | ≤10mm | 95×45×72 | 43.8×36×31.3cm | 72/1 | 16.7kg |
| MF-15 | ≤12mm | 105×55×77 | 46.3×38.5×37.3cm | 72/1 | 22.7kg |

